

Maloobchodní ceník WAJNERT - sedací nábytek -

Ceník je platný od 1.11.2018.
Ceny jsou uvedeny v Kč s DPH 21 %.

LEGENDA (platná od 1.6.2018)

KOLEKCE TKANIN

A1 **DORA:** 23, 24, 27, 40, 86, 90, 91, 95, 96
LENA: 22, 23, 25, 27, 65, 78, 87, 90, 91, 94, 95, 96

A2 **APIA*:** 2302, 2303, 2304, 2308, 2311, 2312, 2313, 2314, 2315, 2316, 2317, 2318, 2319, 2320, 2300
ARTE*: 07, 13, 46, 121, 250, 710, 770, 516
CAMINO: 10, 11, 12, 13, 14, 15, 16, 17, 18, 19, 20
ENERGY: 10, 11, 12, 13, 14, 15, 16, 17, 18, 19, 20, 21
EDEN: 2, 45, 59, 61, 69, 79, 39, 81, 90, 95, 99
NIL: 34, 51, 52, 53, 54, 55, 57, 62, 70
GENUA : 02, 06, 32, 120, 121, 240, 608, 604, 709, 740, 755, 780
HAITI: 01, 03, 09, 34, 24, 19, 16, 17, 41, 11, 36
TEAM: 2, 16, 20, 72, 73, 76, 84, 94, 98

B1 **FUTURA:** 01, 05, 41, 49, 65, 66, 67, 78, 79, 95, 102, 133
MELA: 10, 11, 12, 13, 14, 15, 16, 17, 18, 19, 20, 21, 22, 23, 24, 25, 26, 27, 28
ORION*: 02, 03, 04, 05, 06, 07, 08, 10, 11, 16, 17, 19, 20, 21, 22
WESTERN: 200, 802, 809, 215, 800, 104

B2 **LINATE:** 10, 11, 12, 13, 14, 15, 16, 17, 18, 19, 20, 21, 22, 23
PORTO - 02, 04, 05, 10, 11, 13, 14, 15, 17, 18
PEPE: celá kolekce

B3 **CARABU HP* - celá kolekce**
PERSEMPRA - snadné čištění, NANO STOP system
SOFIA: 2, 4, 5, 6, 8, 11, 13, 16, 17, 19, 26

B4 **AMARA 8* - celá kolekce (HARUKA, NAOMI, NANA, MATSUE) - snadné čištění, AQUA CLEAN system**
AMARA 9
AMARA 10: celá kolekce
MISTIC: celá kolekce
SPIRIT: celá kolekce

KOLEKCE KŮŽÍ

S1 **SKH:** HS01, HS02, HS10, HS15, HS16, HS25, HS26, HS27, HS 28, HS 29, HS 30, HS 31, HS32, HS33, HS34, HS35, HS36, HS37, HS38, HS39

S2 **DSH:** DSH 01, DSH 02, DSH 03, DSH 04, DSH 05, DSH 06, DSH 07 (**NOVINKA**)

KOLEKCE KONTRASTNÍCH NITÍ

K **K0, K1, K2, K3, K4, K5, K6, K7, K8, K9, K10**

BARVY DŘEVĚNÝCH NOHOU

N **N4, N7, N9, N10, N12, N13**

ZNAČENÍ SYMBOLŮ SEDACÍHO A SKŘÍŇOVÉHO NÁBYTKU

BAR - bar	BF - bez f. spaní	BIU - pracovní stůl	CR - noha chromová	DR - šatní tyč	DW - noha dřevěná	FOT - křeslo	H - roh	PC - noha plastová s chrom
KSZ - koš	LAW - stolek	LCK - spoj, článek	LED - lišta LED osvětlení	LOZ - postel	LUS - zrcadlo	M - modul rohovky	MBOX - audio box	ML - noha kovová s chrom
N - noha dřevěná	NAD - nástavec	NAR - rohovka	OSW - osvětlení	OT - otoman	P - úložný prostor	PAN - panel	KOM - komoda	POD - polštář
POJ - úložný prostor	POL - police	PUF - tabureť	R - funkce rozkladu	RAM - zesilující rám	REG - regál	RF - výsuvný sedák	S - rošt	SDD - samodovírání dveří
SFK - skříňka	SFW - skříňka závěs.	SOF - pohovka	STK - stolek	STN - noční stolek	TOL - toaletka	STO - jídelní stůl	SZF - skříň	STNT - noční stolek čaloun.
W - vozík	WER - pohovka	WIE - věšák	WIT - vitrína	ZAG - záhlavek	ZAS - zesilovač			

BARVY SKŘÍŇOVÉHO NÁBYTKU

AT - antracit	VI - fialová	BL - bílá mat	BQ - bílý lesk	BT - buk jádrový	CB - dub craft bílý	CQ - černý lesk	KR - krém mat
CZ - černá mat	I a - buk iconic	DD - dub divoký	DF - dub ferrara	DR - dub sanremo	DS - dub sonoma	DZ - dub craft zlatý	HW - havana/vanilka lesk
KK - kaštan klasický	LT - latte mat	LQ - latte lesk	NC - noce sorento	NV - noce verona	NB - nebeská mat	KQ - slonová kost lesk	SL - borovice loft krém
SQ - šedý lesk	ZQ - zelený lesk	VA - venge arusha	VE - venge tmavé	UB - dub zrbán/ořech real		PQ - pomerančový lesk	
SB - borovice bělená	WR - ořech real	DU - dub urban	IB - buk iconic/bílá	RB - ořech real/bílý lesk			

* VLASTNOSTI VYBRANÝCH KOLEKCÍ TKANIN

APIA, ARTE, MELA, ORION, PEPE, PERSEMPRA, CARABU HP, SPIRIT - v závislosti na úhlu dopadu světla a na jeho intenzitě, určité tkaniny mohou dostávat různý odstín - stínovat. Jde o optický jev a nelze to posuzovat jako vadu materiálu. Pokud by klient tento jev neakceptoval, ať si vybere jiný potahový materiál.

CARABU HP, SPIRIT, MELA - u některých tkanin se může objevit jev "pomačkaných" vláken. Nejedná se o nižší kvalitu materiálu. Pokud by klient tento jev neakceptoval, ať si vybere jiný potahový materiál.

UPOZORNĚNÍ

2. Ceny v ceníku jsou uvedeny v Kč.
3. Neuvedení ceny u nábytku je z důvodu nemožnosti jeho vyrobení v dané cenové skupině.
4. S ohledem na měkké prvky a způsob očalounění nábytku se mohou vyskytnout drobné rozdíly v rozměrech.
5. Pokud v objednávce neuvedete volbu barevnosti N, pak to znamená, že nábytek bude vyroben v barvě N2, což nemůže být důvodem reklamace.
6. Nemožnost koordinace nábytku v kůžích znamená nemožnost spojování různých barev a typů kůží.
7. Čalouněný nábytek vyrobený v kůži může být dodatečně doplněn o prošití, které ve standardu není možno použít na nábytek vyrobený ve tkanině.
8. Není možno vyrobit nábytek v povrchových tkaninách.
9. Není možno vyrobit nábytek ve tkanině na levé straně.
10. Mohou vzniknout rozdíly v odstínech tkanin a kůží mezi vzorníky a hotovým nábytkem jakož a v případě doobjednání nábytku v pozdějším čase.
11. Podrobné informace týkající se možnosti vyrobení nábytku ve tkaninách z aktuální nabídky Vám poskytne obchodní zástupce.
12. V případě pevnějších tkanin mohou nastat potíže s rozkladem na funkci spaní, u bočního otevírání tabureťů a při polohování záhlavků nebo podloketních opěrek. Tato vlastnost není předmětem reklamace.
13. Mohou se vyskytnout rozdíly ve stupni tvrdosti a pružnosti jednotlivých prvků nábytku (polštáře, opěrky, sedáky), vyplývající z jejich rozdílné velikosti nebo použití konstrukčního řešení (funkce rozkladu, úložný prostor). Tato vlastnost není podnětem k reklamaci.
14. Přirozené změny ve vzhledu a pohodlí nábytku umístěného mezi expozicemi, a u nábytku, který je dodán na objednávku přímo klientovi, vycházejí z přirozeného expozičního používání a předvádění v závislosti na použité potahové tkanině. Tato vlastnost není podnětem k reklamaci.
15. Zvuky vycházející ze spojů u kovových konstrukcí jsou přirozenou vlastností při používání tohoto materiálu. Tato vlastnost není podnětem k reklamaci.
16. Presentované vzorníky tkanin, kůží a dřev je potřeba brát jako vzorky, jenž mohou mít od skutečně dodaných materiálů nepatrně odlišný odstín či vzhled.
17. Výrobce si vyhrazuje právo na zavádění změn v barevnosti, vzorech, rozměrech a funkcích nábytku, který se nachází v aktuální nabídce.

ZÁSADY POUŽÍVÁNÍ NÁBYTKU

1. Nábytek lze používat k tomu, čemu je určen a v souladu s pravidly určenými v záručním listu, které jsou přiloženy k nábytku.
2. Sedací nábytek s možností rozložení (funkce spaní) slouží k občasnému spaní, ne každodennímu.
3. V průběhu používání sedaček s měkkými polštáři, je potřeba udržovat jejich tvar (stačí je naklepat) v závislosti na intenzivitě jejich používání. Mějte na paměti, že přirozeným efektem používání jsou záhyby a zvrásnění na potahové látce.

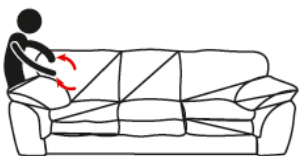

A



B

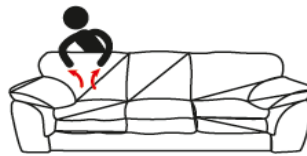

C

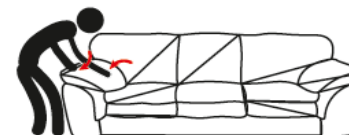

D

- A) formování opěrných polštářků pomocí přesouvání rukou jejich výplně ve směru zespod nahoru
- B) přidržení zadní části polštářku druhou rukou přesouváme jejich výplň
- C) protažení konců polštářků pro jednotné vytvarování k vnějším hranám
- D) formování podloketních opěrek by mělo začít od středu, přesouváním k vnějším hranám

4. Není dovoleno sezení na podloketních opěrkách, stání a skákání na sedácích, opěracích nebo po jednotlivých pružinových pásech.
5. Nábytek je třeba udržovat v čistotě. Nedovolte, aby docházelo k silnému znečištění potahové tkaniny. Díky správné péči udržíte nábytek v pěkném estetickém a funkčním vzhledu po dlouhou dobu.
6. Způsob čištění nábytku se liší podle použitého potahového materiálu. Podrobnosti najdete na kartách tkanin a kůží, které jsou dostupné na vyžádání u distributora či Vašeho prodejce.

VLASTNOSTI TKANIN A KŮŽÍ

1. Kůže mají specifické vlastnosti, které zvýrazňují a dokreslují jejich přírodní původ: různé žíly, tukové záhyby, jizvy, rozdíly v lesku, specifický zápach. Jedná se o vlastnosti, které není možno odstranit, a jsou-li pro Vás neakceptovatelné, vyberte si raději potahovou látku mezi tkaninami.



2. Přirozeným efektem nábytku z kůže je změna měkkosti u sedáků a opěráků.

3. Způsob a četnost čištění koženého nábytku je závislá na intenzitě jeho použití a stupni znečištění. Za účelem udržení ochranné vrstvy kůže, doporučujeme pravidelné čištění a údržbu s použitím speciálních prostředků dostupných na našem trhu. Je důležité, abyste se přesně drželi instrukcí uvedených v návodu u těchto čisticích a ochranných prostředků.

4. Na kůži a potahové tkaniny se může snadno přenést barva z materiálů, které mají špatnou barevnou stálost, např. dřiny. Doporučujeme vyhýbat se takovým materiálům, které poštví barvu, zvláště pak přímému kontaktu takových materiálů s nábytkářskými knoflíky či dekoračními nitěmi, aby nedošlo k jejich poškození.

5. Potahové tkaniny mají řadu přirozených vlastností, které nijak nesnižují jejich užitnou hodnotu ani stálost. Mezi nejčastější takové vlastnosti patří stínování a mačkání vláken.

A) stínování: vizuální efekt, zakládající se na rozdílech v barvě u jednotlivých částí nábytku, které jsou způsobeny jednosměrným uspořádáním vláken, projevující se při různém dopadu světla. Nejvíce je vidět u pohovek, kde se světlo odráží různými směry, v závislosti na uložení daných částí nábytku. Tento efekt není technologickou vadou produktu ani to neznamena, že by šlo o špatné ocalounění. Stínování je přirozenou přírodní vlastností velurů (samety).

B) mačkání vláken: vzniká vlivem zatížení sedící osoby, přirozené vlhkosti a tělesné teploty. Je to podobný efekt jako při žehlení. Jde o typický jev spojený s používáním velurů (samety) a tkanin jim podobných. Tento efekt neznamena sníženou kvalitu materiálu.

BARCELONA

ROZMĚRY (cm)	
hloubka nábytku	101-116
výška nábytku	87-100
výška sezení	43
hloubka sezení	55-74
šířka boku / výška boku	A-21/51, B-31/46, C-31/55

ČALOUNĚNÍ	
koordináty	ne
doplňkové prošití v kůži	ano
omezení tkanin a kůží	tkaniny se vzory
kontrastní prošití	ne

NOHY	
	
NOHA DŘEVĚNÁ N	NOHA KOVOVÁ CR

FUNKCE	
funkce spaní	delfin
úložný prostor	ano - SEGM.1HT
nastavitelné prvky	nastavitelné opěráky- mechanismus západkový, možnost nastavení hloubky sezení
ostatní	

SLOŽENÍ	
opěrák	pěna polyuretanová/ elastický pás
sedák	K- pěna vysoce elastická /lišťová pružina M- pěna polyuretanová/multipoket/lišťová pružina

BOKY		
		
BOK A	BOK B	BOK C
dostupná noha CR.		





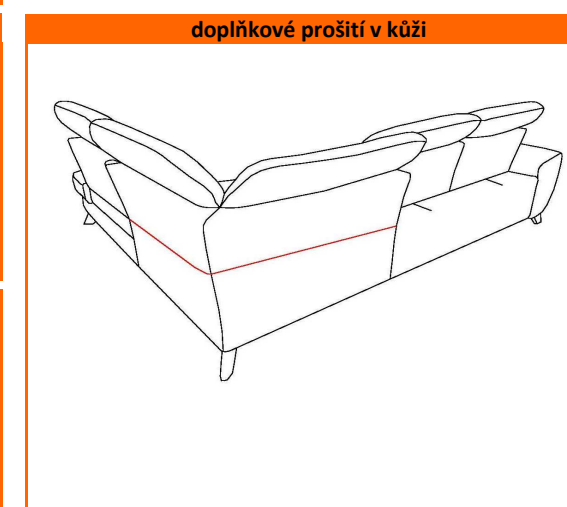















ZPŮSOB ROZKLÁDÁNÍ FUNKCE SPANÍ			
			
ROZKLÁDÁNÍ TYPU 01 (DELFIN)			



















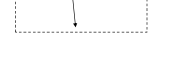





ostatní
<ol style="list-style-type: none"> 1. V případě tkaniny CARABU HT se mohou vyskytnout potíže s polohováním nastavitelných prvků a funkce spaní. 2. U kůží je použito doplňkové prošití. 3. Nohy dřevěné dostupné v 10 barvách, nemožno přimontovat nohu dřevěnou k boku BOK A. 4. Uvedené ceny jsou cenami částečnými. Pro získání celkové prodejní ceny je potřeba sečíst jednotlivé prvky sestavy, a to zapsané zleva doprava, jak jdou po sobě. 5. S ohledem na měkké prvky a způsob očalounění se mohou vyskytnout malé rozdíly v rozměrech nábytku.

BARCELONA

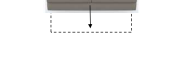
SYMBOL	ROZMĚRY v cm (š / h / v)			POPIS	CENY								OBJEM (m3)	VÁHA (kg)	MNOŽSTVÍ (ks)	
					A1	A2	B1	B2	B3	B4	S1	S2				
KOMFORT k- pěna vysoce elastická	SOF.2,5BF BOK A K			172/101-116/87-100	pohovka 2-osobova z regulowanymi a ruchomymi oparciami	17 790	18 730	19 405	20 194	21 384	22 333	31 942	34 618	1,75	60	1
	SOF.2,5BF BOK B K			192/101-116/87-100										1,95	65	1
	SOF.2,5BF BOK C K			192/101-116/87-100										1,95	65	1
	SOF.3BF BOK A K			237/101-116/87-100	pohovka 3-osobova z regulowanymi a ruchomymi oparciami	23 990	24 990	25 809	26 709	28 067	29 275	42 071	45 612	2,40	92	1
	SOF.3BF BOK B K			257/101-116/87-100										2,60	98	1
SOF.3BF BOK C K			257/101-116/87-100	2,60										98	1	
KOMFORT k- pěna vysoce elastická	SOF.3W BOK A K			237/101-116/87-100	pohovka 3-osobova z funkcją spania, pow.spania 140-198, obsahuje regulowane a nastawitelne opěraky	27 530	28 660	29 461	30 427	31 868	33 149	46 477	49 562	2,40	114	1
	SOF.3W BOK B K			257/101-116/87-100										2,60	118	1
	SOF.3W BOK C K			257/101-116/87-100										2,60	118	1
	SEGM.1BF BB K			65/101-116/87-100	modul bez boków, obsahuje regulowane a nastawitelne opěraky	6 515	6 793	7 054	7 378	7 862	8 280	12 025	12 806	0,80	29	1
	SEGM.1BF BOK A K L/P			86/101-116/87-100	modul z regulowanym a ruchomym opěrakm	9 005	9 470	9 805	10 205	10 798	11 339	16 375	17 313	0,90	35	1
	SEGM.1BF BOK B K L/P			96/101-116/87-100										0,95	38	1
SEGM.1BF BOK C K L/P			96/101-116/87-100	0,95										38	1	
SEGM.2,5BF BB K			130/101-116/87-100	modul bez boków, obsahuje regulowane a nastawitelne opěraky	12 406	12 834	13 272	13 792	14 581	15 287	23 392	15 400	1,20	55	1	
SEGM.2,5W BB K			130/101-116/87-100	modul z funkcją spania, pow.spania min. 140-198, obsahuje regulowane a nastawitelne opěraky, przeznaczony wyłącznie do budowy narożników	16 133	16 580	17 026	17 547	18 346	19 052	28 141	29 618	1,20	69	1	

	ROZMĚRY v cm (š / h / v)			POPIS	CENY								OBJEM (m3)	VÁHA (kg)	MNOŽSTVÍ (ks)	
					A1	A2	B1	B2	B3	B4	S1	S2				
KOMFORT K - péna vysoce elastická	SEGM.2,5BF BOK A K L/P			151/101-116/87-100	modul z regulovanými a ruchomými oparciami	15 660	16 439	16 988	17 658	18 671	19 563	28 067	30 306	1,50	61	1
	SEGM.2,5BF BOK B K L/P			161/101-116/87-100										1,60	63	1
	SEGM.2,5BF BOK C K L/P			161/101-116/87-100										1,60	63	1
	SEGM.2,5W BOK A K L/P			151/101-116/87-100	modul z funkcją spania, pow.spania min.140-198, obsahuje regulowane a nastaviteľné opěráky, určený výhradně do budovy narožníků	19 098	19 897	20 454	21 134	22 175	23 075	32 378	34 795	1,50	75	1
	SEGM.2,5W BOK B K L/P			161/101-116/87-100										1,60	77	1
	SEGM.2,5W BOK C K L/P			161/101-116/87-100										1,60	77	1
	SEGM.2OT K L/P			213-220/100-107/87-100	modul z regulovanými oparciami, krawędziowe opěrák jest również ruchome	19 897	20 781	21 374	22 091	23 160	24 116	35 269	37 936	2,20	77	1
	SEGM.1HT K L/P			107-114/110/87-100	modul z pojemníkem, obsahuje regulované a ručome opěrák, možná připojit jedině z elementem SEGM.H	11 115	11 579	11 896	12 277	12 872	13 364	18 782	20 214	1,20	50	1
	SEGM.H K			100-107/100-107/87-100	modul narožný z regulovanými oparciami	9 759	10 352	10 772	11 272	12 017	12 741	18 364	19 907	1,70	38	1
KOMFORT M - MULTIPOKET	SOF.2,5BF BOK A M			172/101-116/87-100	pohovka 2-osobová z regulovanými a ruchomými oparciami	17 990	18 990	19 750	20 521	21 560	22 490	32 100	34 777	1,70	60	1
	SOF.2,5BF BOK B M			192/101-116/87-100										1,90	65	1
	SOF.2,5BF BOK C M			192/101-116/87-100										1,90	65	1

	ROZMĚRY v cm (š / h / v)			POPIS	CENY								OBJEM (m3)	VÁHA (kg)	MNOŽSTVÍ (ks)	
					A1	A2	B1	B2	B3	B4	S1	S2				
KOMFORT M - MULTIPOKET	SOF.3BF BOK A M			237/101-116/87-100	pohovka 3-osobowa z regulowanymi a ruchomymi oparciami	23 990	24 990	25 990	26 848	28 206	29 582	42 258	45 753	2,40	92	1
	SOF.3BF BOK B M			257/101-116/87-100										2,60	98	1
	SOF.3BF BOK C M			257/101-116/87-100										2,60	98	1
	SOF.3W BOK A M			237/101-116/87-100	pohovka 3-osobowa z funkcją spania, pow.spania 140-198, obsahuje regulowane a nastawitelne opěraky	28 490	29 590	29 990	31 329	32 769	34 051	46 830	50 464	2,40	114	1
	SOF.3W BOK B M			257/101-116/87-100										2,60	118	1
	SOF.3W BOK C M			257/101-116/87-100										2,60	118	1
	SEGM.1BF BB M			65/101-116/87-100	modul bez boków, obsahuje regulowane a nastawitelne opěraky	6 729	7 007	7 267	7 584	8 066	8 504	12 285	12 973	0,80	29	1
	SEGM.1BF BOK A M L/P			86/101-116/87-100	modul z regulowanym a ruchomym opěrakm	9 406	9 870	10 205	10 604	11 199	11 738	16 589	17 714	0,90	35	1
	SEGM.1BF BOK B M L/P			96/101-116/87-100										1,00	38	1
	SEGM.1BF BOK C M L/P			96/101-116/87-100										1,00	38	1
	SEGM.2,5BF BB M			130/101-116/87-100	modul bez boków, obsahuje regulowane a nastawitelne opěraky	12 927	13 373	13 810	14 339	15 148	15 846	23 708	25 008	1,10	55	1
	SEGM.2,5W BB M			130/101-116/87-100	modul z funkcją spania, pow.spania min. 140x198, obsahuje regulowane a nastawitelne opěraky, przeznaczony wyłącznie do budowy narożników	16 542	17 006	17 444	17 983	18 782	19 488	28 262	29 935	1,10	69	1
	SEGM.2,5BF BOK A M L/P			151/101-116/87-100	modul z regulowanymi a ruchomymi oparciami	16 013	16 802	17 341	18 029	19 024	19 926	28 216	30 464	1,50	61	1
	SEGM.2,5BF BOK B M L/P			161/101-116/87-100										1,60	63	1
	SEGM.2,5BF BOK C M L/P			161/101-116/87-100										1,60	63	1

	ROZMĚRY v cm (š / h / v)			POPIS	CENY								OBJEM (m3)	VÁHA (kg)	MNOŽSTVÍ (ks)	
					A1	A2	B1	B2	B3	B4	S1	S2				
KOMFORT K - pěna vysoce elastická	SEGM.2,5W BOK A M L/P			151/101-116/87-100	modul z funkcí spania, pow.spania min. 140-198, obsahuje regulované a nastavitelné opěrky, przeznaczony wyłącznie do budowy narożników	19 451	20 241	20 817	21 487	22 528	23 428	32 463	34 878	1,50	75	1
	SEGM.2,5W BOK B M L/P			161/101-116/87-100										1,60	77	1
	SEGM.2,5W BOK C M L/P			161/101-116/87-100										1,60	77	1
	SEGM.2OT M L/P			213-220/100-107/87-100	modul z regulowanymi oparciami, krawędziowe opėrak jest również ruchome	20 129	20 967	21 560	22 276	23 345	24 294	35 594	38 112	2,20	77	1
	SEGM.1HT M L/P			107-114/110/87-100	modul z pojemnikiem, obsahuje regulované a ruchome opėrak, možna łączyc jedynie z elementem SEGM.H	11 254	11 700	12 025	12 406	12 973	13 504	18 913	20 333	1,20	50	1
	SEGM.H M			100-107/100-107/87-100	modul narożny z regulowanymi oparciami	9 898	10 492	10 911	11 403	12 156	12 769	18 439	19 934	1,10	38	1
	PUF.S 45x45			45/45/43	pufa- występuje wyłącznie v komforcie K	2 310	2 460	2 550	2 685	2 863	3 039	4 386	4 693	0,10	9	1
	PUF.M 65x65			65/65/43	pufa- występuje wyłącznie v komforcie K	2 990	3 240	3 370	3 513	3 727	3 912	5 845	6 376	0,20	13	1
	PUF.L 135x65			135x65/43	pufa- występuje wyłącznie v komforcie K, obsahuje ruchome koła (możliwość użycia blokady v dwóch kołach v celu unieruchomienia)	7 290	7 560	7 760	7 992	8 345	8 652	11 171	11 692	0,40	21	1
	MAT.2,5	materacyk zatapicerowany tkaniną właściwą mebla, dotyczy SEGM.2,5W			902	1 170	1 366	1 598	1 951	2 574			netýká se			
	MAT.3	materacyk zatapicerowany tkaniną właściwą mebla, dotyczy SOF.3W			1 134	1 515	1 784	2 110	2 593	3 020						

SESTAVA OBSAHUJE FUNKCI SPANÍ



SEGM.1BF L + SEGM.H + SEGM.2,5W P



SEGM.2,5W + SEGM.H + SEGM.1BF P

KOMFORT K

	CENA							
	A1	A2	B1	B2	B3	B4	S1	S2
BOK A	37 862	39 720	41 031	42 611	44 990	47 155	67 117	72 015
BOK B	37 862	39 720	41 031	42 611	44 990	47 155	67 117	72 015
BOK C	39 952	41 913	43 317	44 980	47 462	49 729	70 436	75 724

KOMFORT M

	CENA							
	A1	A2	B1	B2	B3	B4	S1	S2
BOK A	38 754	40 604	41 932	43 493	45 882	47 936	67 490	72 526
BOK B	38 754	40 604	41 932	43 493	45 882	47 936	67 490	72 526
BOK C	40 854	42 805	44 209	45 854	48 353	50 510	70 797	76 224



SESTAVA OBSAHUJE FUNKCI SPANÍ

SEGM.1HT L + SEGM.H + SEGM.2,5 W P

SEGM.2,5 W L + SEGM.H + SEGM.1HT P

KOMFORT K		CENA							
		A1	A2	B1	B2	B3	B4	S1	S2
BOK A		39 970	41 830	43 122	44 683	47 062	49 181	69 524	74 915
BOK B		39 970	41 830	43 122	44 683	47 062	49 181	69 524	74 915
BOK C		40 947	42 871	44 227	45 845	48 271	50 464	71 318	76 801

KOMFORT M		CENA							
		A1	A2	B1	B2	B3	B4	S1	S2
BOK A		40 604	42 434	43 753	45 297	47 657	49 701	69 812	75 147
BOK B		40 604	42 434	43 753	45 297	47 657	49 701	69 812	75 147
BOK C		41 588	43 485	44 851	46 449	48 866	50 984	71 598	77 025



SEGM.2OT L + SEGM.2,5BF P

SEGM.2,5BF L + SEGM.2OT P

KOMFORT K		CENA							
		A1	A2	B1	B2	B3	B4	S1	S2
BOK A		35 558	37 220	38 364	39 748	41 830	43 679	63 336	68 243
BOK B		35 558	37 220	38 364	39 748	41 830	43 679	63 336	68 243
BOK C		36 542	38 271	39 470	40 910	43 057	44 972	65 129	70 137

KOMFORT M		CENA							
		A1	A2	B1	B2	B3	B4	S1	S2
BOK A		36 143	37 769	38 903	40 305	40 305	44 219	63 810	68 577
BOK B		36 143	37 769	38 903	40 305	40 305	44 219	63 810	68 577
BOK C		37 146	38 818	40 009	41 457	41 457	45 510	65 612	70 472



SEGM.2,5BF L + SEGM.H + SEGM.2,5BF P

SEGM.2,5 BF L + SEGM.H + SEGM.2,5BF P

KOMFORT K		CENA							
		A1	A2	B1	B2	B3	B4	S1	S2
BOK A		41 078	43 233	44 748	46 588	49 358	51 866	74 497	80 519
BOK B		41 078	43 233	44 748	46 588	49 358	51 866	74 497	80 519
BOK C		43 047	45 333	46 959	48 912	51 811	54 450	78 084	84 311

KOMFORT M		CENA							
		A1	A2	B1	B2	B3	B4	S1	S2
BOK A		41 923	44 098	45 593	47 462	50 203	52 620	74 868	80 863
BOK B		41 923	44 098	45 593	47 462	50 203	52 620	74 868	80 863
BOK C		43 931	46 198	47 806	49 766	52 693	55 203	78 474	84 654

ROZMĚRY (cm)	
hloubka nábytku	108
výška nábytku	85/103
výška sezení	44
hloubka sezení	58
šířka boku / výška boku	16/62

ČALOUNĚNÍ	
koordináty	ne
doplňkové prošití v kůži	ano - na zádech korpusu
omezení tkanin a kůží	tkaniny se vzory
kontrastní prošití	ne

FUNKCE	
funkce spaní	leopard
úložný prostor	1OT, 1HT
nastavitelné prvky	nastavitelný záhlavek
ostatní	funkce relax

SLOŽENÍ	
sedák	pěna vysoce elastická, lištová pružina
opěrák	pěna vysoce elastická, čalounický pás



ZPŮSOB ROZKLÁDÁNÍ FUNKCE SPANÍ

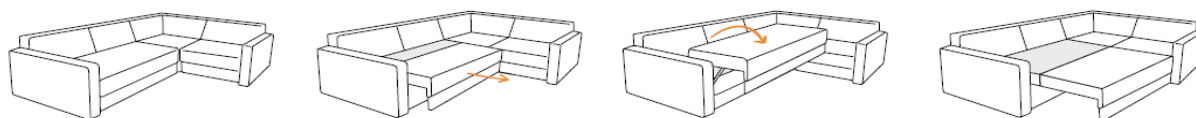

ROZKLÁDÁNÍ TYPU 04 (LEOPARD)

TYPY BOKŮ



BOK A NOHA DŘEVĚNÁ N NEBO KOVOVÁ CR

BOK B S KOVOVÁ OBRUČÍ S NOHOU DŘEV. N NEBO KOVOVOU CR

doplňkové prošití v kůži

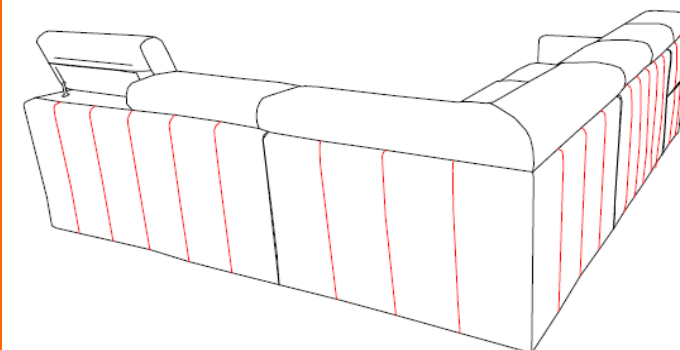









ostatní

1. V případě tkaniny CARABU HT se mohou vyskytnout potíže s polohováním nastavitelných prvků a funkce spaní.
2. U kůží je použito doplňkové prošití.
3. Nohy a doplňkové prvky dřevěné dostupné v 10 barvách
4. Uvedené ceny jsou cenami částečnými. Pro získání celkové prodejní ceny je potřeba sečíst jednotlivé prvky sestavy a boky, a to zapsané zleva doprava, jak jdou po sobě.
5. S ohledem na měkké prvky a způsob očalounění se mohou vyskytnout malé rozdíly v rozměrech nábytku.

BELIZE

SYMBOL	ROZMĚRY (š / h / v)		POPIS	CENY								OBJEM (m3)	VÁHA (kg)	MNOŽSTV ě (ks)
				A1	A2	B1	B2	B3	B4	S1	S2			
FOT.BF	94/108/85-103		křeslo	12 190	12 950	13 490	14 127	15 102	15 975	21 990	23 941	0,85	42	1
FOT.RE	94/108/85-103		křeslo z funkce relax	21 390	22 190	22 740	23 392	24 376	25 268	31 216	33 131	0,9	67	1
SOF.2BF	152/108/85-103		pohovka bez funkce	14 990	15 890	16 490	17 202	18 279	19 238	25 734	27 695	1,4	67	1
SOF.3BF	173/108/85-103		pohovka bez funkce	16 390	17 290	17 990	18 707	19 897	20 947	27 955	30 064	1,6	69	1
SEGM.1BF L/P	77/108/85-103		modul jednosedákový	8 847	9 442	9 870	10 390	11 153	11 831	16 496	17 908	0,7	32	1
SEGM.1RE L/P	77/108/85-103		modul z funkce relax	18 086	18 689	19 127	19 637	20 428	21 124	25 660	27 100	0,75	57	1
SEGM.2BF L/P	135/108/85-103		modul dwusedákový	11 718	12 388	12 880	13 457	14 331	15 102	20 176	21 673	1,25	57	1
SEGM.3BF L/P	157/108/85-103		modul dwusedákový	13 001	13 764	14 313	14 962	15 939	16 793	22 397	24 042	1,45	59	1
SEGM.3R L/P	157/108/85-103		modul z funkcí spania, pow. spania min.140x198, przeznaczony wyłącznie do budowy narożników	17 880	18 671	19 228	19 907	20 920	21 812	27 592	29 321	1,5	87	1
SEGM.1OT L/P	91/173/85-103		modul z pojemníkem	13 578	14 220	14 674	15 233	16 050	16 784	21 812	23 345	1,35	65	1
SEGM.1BF BB	60/108/85-103		modul jednosedákový bez boků	5 512	5 958	6 255	6 636	7 193	7 695	10 883	11 821	0,55	22	1

ELEMENTY Z BOKAMI A NEBO B

SYMBOL	ROZMĚRY (š / h / v)		POPIS	CENY								OBJEM (m3)	VÁHA (kg)	MNOŽSTV ě (ks)	
				A1	A2	B1	B2	B3	B4	S1	S2				
ELEMENTY BEZ BOKU	SEGM.2BF BB	119/108/85-103		modul dwusedákwy bez boków	8 383	8 894	9 265	9 703	10 381	10 966	14 609	15 650	1,1	47	1
	SEGM.3BF BB	141/108/85-103		modul dwusedákwy bez boków	9 684	10 279	10 705	11 208	11 979	12 666	16 841	18 011	1,3	49	1
	SEGM.3R BB	141/108/85-103		modul bez boków z funkcją spania, pow. spania min.140x198, przeznaczony wyłącznie do budowy narożników	14 545	15 176	15 622	16 153	16 960	17 686	22 026	23 289	1,35	77	1
	SEGM.H	108/108/85		modul narożny	7 788	8 532	9 061	9 703	10 669	11 524	16 439	17 843	1	46	1
	SEGM.1HT L/P	105/101/85-103		modul z pojemnikiem	9 228	9 749	10 112	10 558	11 226	11 803	15 707	16 859	0,95	36	1
	STS.I	47/102/45		stolik okolicznościowy, wolnostojący, z elementami wykonanymi w fornirze v kolorystyce N	5 230	5 360	5 440	5 548	5 716	5 865	5 827	5 990	0,45	27	1
	STS.II	47/102/45		stolik z zaczepami umożliwiającymi łączenie dwóch modułów, z elementami wykonanymi v fornirze v kolorystyce N	5 230	5 360	5 440	5 548	5 716	5 865	5 827	5 990	0,45	27	1
ELEMENTY UZUPEŁNIAJĄCE	PUF.BF	65/65/45		pufa	3 110	3 320	3 470	3 652	3 930	4 172	5 558	5 990	0,2	13,5	1
	MAT.3	materacyk tapicerowany tkaniną właściwą mebla			902	1 170	1 366	1 598	1 951	2 574			netýká se		
	AKU.	akumulator			4 693								netýká se		

UKÁZKOVÉ SESTAVY



SEGM.3R L + SEGM.10T P obsahuje funkci spaní

CENY							
A1	A2	B1	B2	B3	B4	S1	S2
31 458	32 890	33 903	35 138	36 970	38 596	49 404	52 667



SEGM.3R L + SEGM.H + SEGM.1HT P obsahuje funkci spaní

CENY							
A1	A2	B1	B2	B3	B4	S1	S2
34 896	36 942	38 401	40 166	42 805	45 147	59 748	64 032



SEGM.1RE L + SEGM.2BF L + SEGM.H + SEGM.3R P obsahuje funkci spaní a FUNKCJĘ RELAX

CENY							
A1	A2	B1	B2	B3	B4	S1	S2
52 136	54 794	56 672	58 958	62 388	65 436	84 301	89 914



SEGM.1RE L + SEG,1BF BB + SEGM.H + SEGM.3R BB + SEGM.10T P obsahuje funkci spaní a FUNKCE RELAX

CENY							
A1	A2	B1	B2	B3	B4	S1	S2
59 506	62 573	64 738	67 369	71 299	74 812	96 830	103 399



SEGM.1HT L+ SEGM.H + SEGM.3RBB + SEG.1OT P obsahuje funkci spaní

CENY							
A1	A2	B1	B2	B3	B4	S1	S2
45 139	47 675	49 469	51 644	54 906	57 796	76 002	81 347

ROZMĚRY (cm)	
hloubka nábytku	100
výška nábytku	98
výška sezení	40
hloubka sezení	56
šířka boku / výška boku	27/60

ČALOUNĚNÍ	
KOORDINÁTY	ne
doplňkové prošití v kůži	ano
omezení tkanin a kůží	tkaniny se vzory
kontrastní prošití	ne

NOHY	
	
NOHA DŘEVĚNÁ N	

FUNKCE	
funkce spaní	rošt belgický
úložný prostor	ne
nastavitelné prvky	ne
ostatní	

SLOŽENÍ	
sedák	směs silikonu a pěny
opěrák	pěna polyuretanová/ lištová pružina

KOORDINÁTY	
NE	











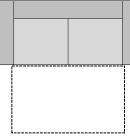

DOPLŇKOVÉ PROŠITÍ V KŮŽI	
NE	

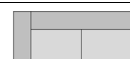
ZPŮSOB ROZKLÁDÁNÍ FUNKCE SPANÍ	
	
ROZKLÁDÁNÍ TYPU 05 (ROŠT)	

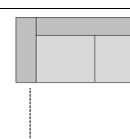
ostatní	
<ol style="list-style-type: none"> U kůží je použito doplňkové prošití. S ohledem na měkké prvky a způsob očalounění se mohou vyskytnout malé rozdíly v rozměrech nábytku. Uvedené ceny jsou cenami částečnými. Pro získání celkové prodejní ceny je potřeba sečíst jednotlivé prvky sestavy a boky, a to zapsané zleva doprava, jak jdou po sobě. Správný postup zápisu vybraných prvků na objednávce je jejich postupné uvedení zleva doprava. 	

BERGEN

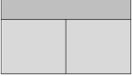
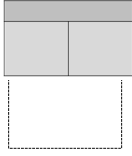
SYMBOL	ROZMĚRY (š / h / v)		POPIS	CENA								OBJEM (m3)	VÁHA (kg)	MNOŽSTVÍ (ks)
				A1	A2	B1	B2	B3	B4	S1	S2			
FOT.BF	105/100/98		fotel	9 390	9 990	10 632	11 264	12 212	13 903	18 233	19 601	1,1	45	1
SOF.2BF	175/100/98		Sofa	12 955	13 890	14 590	15 390	16 590	18 590	24 590	26 290	1,8	60	1
SOF.3BF	225/100/98		Sofa	15 790	16 890	17 590	18 590	19 990	22 590	29 790	31 990	2,35	74	1
SOF.2,5S	197/100/98		Sofa z funkcją spania, nie posiada pojemnika, pow. spania 138x185	17 990	18 990	19 990	20 590	21 890	23 990	29 990	31 990	2,05	78	1
SEG.1BF L/P	83/100/98		Moduł bezfunkcyjny	6 811	7 332	7 713	8 169	8 839	10 037	13 020	14 042	0,85	32	1
SEG.2BF L/P	155/100/98		Moduł bezfunkcyjny	10 705	11 125	11 625	12 249	13 169	14 805	19 980	21 282	1,6	56	1
SEG.2P L/P	155/100/98		Moduł z pojemnikiem	15 093	15 846	16 403	17 053	18 039	19 766	24 897	26 933	1,6	57	1
SEG.3BF L/P	206/100/98		Moduł bezfunkcyjny	13 179	14 089	14 740	15 519	16 681	18 754	24 534	26 366	2,15	60	1
SEG.2,5S L/P	180/100/98		Moduł z funkcją spania, nie posiada pojemnika, pow. spania 138x185	15 622	16 366	16 895	17 547	18 493	18 493	20 194	25 325	1,85	74	1
SEG.1BF BB	61/100/98		Moduł bezfunkcyjny, bez boków	4 257	4 572	4 786	5 064	5 464	6 180	7 798	8 466	0,65	20	1
SEG.2BF BB	133/100/98		Moduł bezfunkcyjny, bez boków	7 853	8 355	8 718	9 154	9 795	10 947	14 107	15 194	1,4	36	1

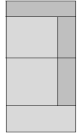
	ROZMĚRY (š / h / v)		POPIS	CENA								OBJEM (m3)	VÁHA (kg)	MNOZST VÍ (ks)
				A1	A2	B1	B2	B3	B4	S1	S2			
SEG.3BF BB	184/100/98		Moduľ bezfunkcyjny, bez boków	10 632	11 329	11 831	12 426	13 308	14 898	19 312	20 807	1,9	48	1
SEG.2,5S BB	158/100/98		Moduľ z funkcją spania, nie posiada pojemnika, pow. spania 138x185	13 066	13 596	13 978	14 442	15 130	16 338	19 720	20 827	1,65	70	1
SEG.H	103/103/98		Moduľ narożny	10 873	11 617	11 896	12 174	13 197	14 127	17 843	18 578	1,1	40	1
SEG.2OT L/P	226/100/98		Otomana, nie posiada pojemnika	16 300	17 351	18 104	18 996	20 333	22 722	30 064	32 164	2,35	77	1

ROZMĚRY (cm)	
hloubka nábytku	97
výška nábytku	104
výška sezení	47
hloubka sezení	55
šířka boku / výška boku	26/62

ČALOUNĚNÍ	
koordináty	ne
doplňkové prošití v kůži	ano
omezení tkanin a kůží	tkaniny se vzory
kontrastní prošití	ne

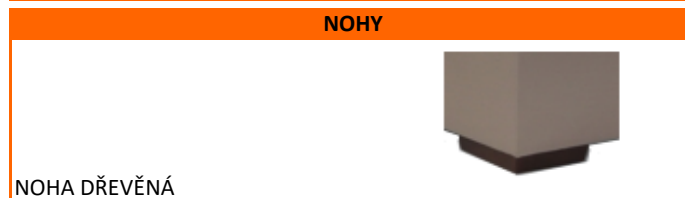





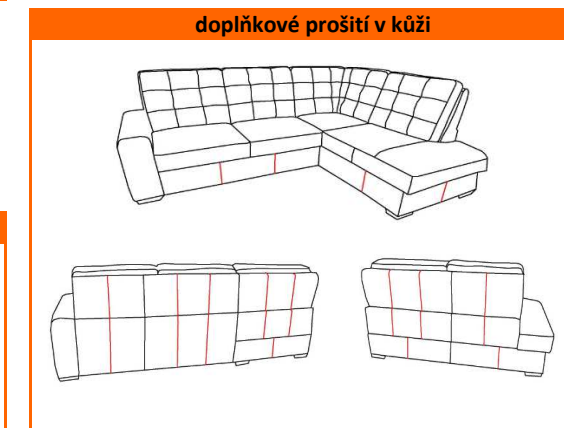









FUNKCE	
funkce spaní	delfin
úložný prostor	ano - SOF.2P, SEGM.20, SEGM.10T, SEGM.20T
nastavitelné prvky	ne
ostatní	ne





SLOŽENÍ	
sedák	pěna vysoce elastická/ lištová pružina
opěrák	pěna polyuretanová + potah se směsí silikonu a pěny



ostatní	
<ol style="list-style-type: none"> Nábytek bez koordinátů U kůží je použito doplňkové prošití V případě tkanin CARABU HT se mohou vyskytnout potíže při rozkládání funkce spaní Nohy dřevěné v dostupných barvách N S ohledem na měkké prvky a způsob očalounění se mohou vyskytnout malé rozdíly v rozměrech nábytku 	

BRAVO

SYMBOL	ROZMĚRY (š / h / v)		POPIS	CENY								OBJEM (m3)	VÁHA (kg)	MNOŽSTVÍ
				A1	A2	B1	B2	B3	B4	S1	S2			
FOT.BF/ 2010	107/97/104		křeslo	9 490	9 990	10 490	10 957	11 692	12 444	18 800	21 217	1,10	39	1
SOF.2P/ 2020P	165/97/104		pohovka z pojevníkem	13 990	14 790	15 290	15 911	16 821	17 630	25 353	28 783	1,65	66	1
SOF.3BF/ 2030	194/97/104		pohovka	15 990	16 830	17 408	18 094	19 127	20 047	30 492	34 442	2,10	59	1
SOF.3W/ 2030W	206/97/104		pohovka z funkcí spania, pow.spania 154x195	25 990	26 990	27 690	28 502	29 757	30 631	38 754	43 354	2,10	108	1
SEGM.1BF L/ 1110	85/97/104		modul	7 445	7 881	8 187	8 559	9 117	9 378	14 934	17 101	0,85	33	1
SEGM.1BF P/ 1120	85/97/104		modul											
SEGM.2P L/ 1120P	146/97/104		modul z pojevníkem	12 584	13 253	13 679	14 192	14 962	15 808	24 052	27 415	1,45	60	1
SEGM.2P P/1220P	146/97/104		modul z pojevníkem											
SEGM.3W L/ 1130W	174/97/104		modul z funkcí spania, može být stosowana wyłącznie przy tworzeniu narożników	16 357	17 035	17 519	18 104	18 977	19 766	28 149	31 747	1,70	75	1
SEGM.3W P/1230W	174/97/104		modul z funkcí spania, može být stosowana wyłącznie przy tworzeniu narożników											
SEGM.1BB/0010	60/97/104		modul	5 512	5 827	6 051	6 329	6 739	7 100	11 571	12 909	0,50	30	1
SEGM.3BF BB/0030	150/97/104		modul	11 607	12 323	12 816	13 429	14 163	14 851	21 979	24 869	1,55	57	1
SEGM.3W BB/ 0030W	150/97/104		modul z funkcí spania, može být stosowana wyłącznie przy tworzeniu narożników	14 581	15 186	15 594	16 078	16 802	17 490	24 619	27 695	1,55	69	1
SEGM.H/ 7010	97/97/104		modul narożny	9 228	9 703	10 046	10 465	11 078	11 617	16 217	18 289	1,00	37	1

SYMBOL	ROZMĚRY (š / h / v)	POPIS	CENY									OBJEM (m3)	VÁHA (kg)	MNOŽSTVÍ (ks)	
			A1	A2	B1	B2	B3	B4	S1						
BRAVO	SEGM.1OT L/ 5110	166/103/104		moduľ z pojemníkem, lewy	13 661	14 228	14 637	15 130	15 872	16 542	23 428	26 412	1,75	81	1
	SEGM.1OT P/ 5210	166/103/104		moduľ z pojemníkem, prawy											
	SEGM.2OT L/ 5120	206/103/104		moduľ z pojemníkem, lewy	16 784	17 601	18 178	18 875	19 926	20 882	28 633	32 295	2,0	81	1
	SEGM.2OT P/ 5220	206/103/104		moduľ z pojemníkem, prawy											
	BRAVO.MAT	netýká se	materacyk tapicerowany tkaniną dot. naroźnika	902	1 170	1 366	1 598	1 951	2 574					netýká se	

UKÁZKOVÉ SESTAVY

SESTAVA OBSAHUJE FUNKCI SPANÍ



SEGM.3W L/ 1130W + SEGM.2OT P/5220



OPCJA: SEGM.2OT L/5120 + SEGM.3W P/1230W

CENA

A1	33 141
A2	34 636
B1	35 697
B2	36 978
B3	38 903
B4	40 650
S1	56 783
S2	64 042



SEGM.3W L/ 1130W + SEGM.H/ 7010 + SEGM.1BF P/ 1120



OPCJA: SEGM.1BF L/ 1110 + SEGM.H/ 7010 + SEGM.3W L/ 1230W

SESTAVA OBSAHUJE FUNKCI SPANÍ

CENA

A1	33 030
A2	34 618
B1	35 752
B2	37 128
B3	39 171
B4	40 761
S1	59 301
S2	67 137



SEGM.2P L/ 1120P + SEGM.H/ 7010 + SEGM.3W P/ 1230W



OPCJA: SEGM.3W L/ 1130W + SEGM.H/ 7010 + SEGM.2P P/1220P

SESTAVA OBSAHUJE FUNKCI SPANÍ

CENA

A1	38 169
A2	39 990
B1	41 245
B2	42 759
B3	45 018
B4	47 193
S1	68 418
S2	59 162



SEGM.2P L/1120P+SEGM.H/ 7010+SEGM.3W BB/ 0030W+SEGM.1OT P/ 5210



SEGM.1OT P/ 5210+SEGM.3W BB/ 0030W +SEGM.H/ 7010 + SEGM.2P L/1120 P

SESTAVA OBSAHUJE FUNKCI SPANÍ

CENA

A1	50 054
A2	52 368
B1	53 958
B2	55 863
B3	58 716
B4	61 458
S1	88 316
S2	99 812

ROZMĚRY (cm)		FUNKCE	
hloubka nábytku	100	funkce spaní	rošt italský
výška nábytku	91	úložný prostor	ano: SEGM.1HT, SEGM.1OT
výška sezení	45	nastavitelné prvky	ne
hloubka sezení	55	ostatní	
šířka boku / výška boku	23		

ČALOUNĚNÍ	
KOORDINÁTY	ano
DOPLŇKOVÉ PROŠITÍ V KŮŽI	ano
omezení tkanin a kůží	není možné spojení kůže s tkaninou MELA
kontrastní prošíání	ne

SLOŽENÍ	
sedák	polštářek se směsí silikonu a pěny
opěrák	pěna vysoce elastická



NOHY	
NOHY TECHNICKÉ	

BOKY	

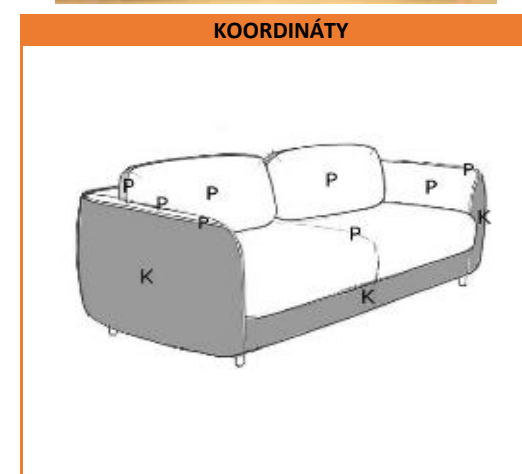





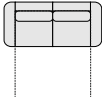
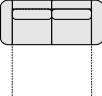
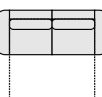
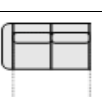
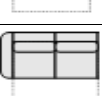

ZPŮSOB ROZKLÁDÁNÍ FUNKCE SPANÍ

ROZKLÁDÁNÍ TYPU 06 (ROŠT ITALSKÝ)

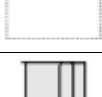
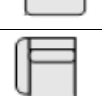
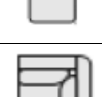
- ostatní**
- Nábytek s koordináty.
 - V případě tkaniny: CARABU HP se mohou vyskytnout potíže při rozkládání funkce spaní.
 - V případě čalounění přírodní kůží se používá doplňkové prošíání.
 - Uvedené ceny jsou cenami částečnými. Pro získání celkové prodejní ceny je potřeba sečíst jednotlivé prvky sestavy a boky, a to zapsané zleva doprava, jak jdou po sobě.
 - S ohledem na měkké prvky a způsob očalounění se mohou vyskytnout malé rozdíly v rozměrech nábytku.
 - Správný postup zápisu vybraných prvků na objednávce je jejich postupné uvedení zleva doprava.

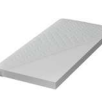
CALI

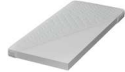
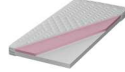
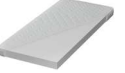
SYMBOL	ROZMĚRY (š / h / v)		POPIS	CENA								OBJEM (m3)	VÁHA (kg)	MNOZS TVÍ (ks)
				A1	A2	B1	B2	B3	B4	S1	S2			
SOF.3S 120	192/100/91		Sofa z funkcją spania, nie posiada pojemnika, pow. spania 120x196, możliwość wyboru materaca: VP, HR lub VISCO	21 990	23 290	23 990	24 990	26 390	27 690	32 990	35 790	1,35	119	2
SOF.3S 140	212/100/91		Sofa z funkcją spania, nie posiada pojemnika, pow. spania 140x196, możliwość wyboru materaca: VP, HR lub VISCO	23 490	24 790	25 790	26 790	28 390	29 890	36 990	39 990	1,5	121	2
SOF.3S 160	232/100/91		Sofa z funkcją spania, nie posiada pojemnika, pow. spania 160x196, możliwość wyboru materaca: VP, HR lub VISCO	23 990	25 390	26 390	27 490	28 990	30 690	39 390	43 390	1,6	125	2
SEG.3S 120	169/100/91		Moduł z funkcją spania, nie posiada pojemnika, pow. spania 120x196, możliwość wyboru materaca: VP, HR lub VISCO	20 287	21 282	21 979	22 843	24 108	25 242	28 680	31 012	1,15	115	2
SEG.3S 140	188/100/91		Moduł z funkcją spania, nie posiada pojemnika, pow. spania 140x196, możliwość wyboru materaca: VP, HR lub VISCO	21 003	22 008	22 722	23 568	24 851	25 975	31 569	34 424	1,3	117	2
SEG.3S 160	207/100/91		Moduł z funkcją spania, nie posiada pojemnika, pow. spania 160x196, możliwość wyboru materaca: VP, HR lub VISCO	22 230	23 428	24 294	25 315	26 858	28 234	35 110	38 596	1,45	119	2
SEG.1HT L/P	136/102/91		Moduł z pojemnikiem	11 171	11 906	12 426	13 048	14 006	14 851	18 067	19 954	1,2	55	1
SEG.1OT L/P	170/105/91		Otomana z pojemnikiem	12 973	13 940	14 637	15 473	16 728	17 853	21 737	24 201	1,35	65	1
SEG.H	102/102/91		Moduł narożny	7 824	8 522	9 015	9 618	10 502	11 301	13 847	15 519	1,1	43	1
SEG.3BF L/P	169/100/91		Moduł bezfunkcyjny	14 573	15 558	16 264	17 109	18 392	19 516	27 955	31 450	1,35	77	1
MAT.VP.120	120/196/14		materac wykonany z pianki poliuretanowej o grubości 14 cm, obszyty membranową tkaniną materacową , wykończony obustronnie lamówką	2 970								Matrace balená s roštem		

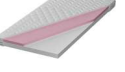
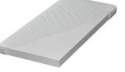
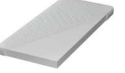
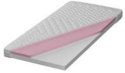
	ROZMĚRY (š / h / v)		POPIS	CENA						OBJEM (m3)	VÁHA (kg)	MNOŽS TVÍ (ks)
				A1	A2	B1	B2	B3	B4			
MAT.HR 120	120/196/14		materac wykonany z pianki wysokoelastycznej o grubości 14 cm, obsyty membranową tkaniną materacową , wykończony obustronnie lamówką	4 830						Matrace balená s roštěm		
MAT.VISCO 120	120/196/14		materac dwurdzeniowy, połączenie pianki wysokoelastycznej z pianką termoelastyczną (memory foam), grubość materaca 14 cm, całość obszyta membranową tkaniną materacową , wykończoną obustronnie lamówką	6 870						Matrace balená s roštěm		
MAT.VP.140	140/196/14		materac wykonany z pianki poliuretanowej o grubości 14 cm, obsyty membranową tkaniną materacową , wykończony obustronnie lamówką	3 290						Matrace balená s roštěm		
MAT.HR 140	140/196/14		materac wykonany z pianki wysokoelastycznej o grubości 14 cm, obsyty membranową tkaniną materacową , wykończony obustronnie lamówką	5 820						Matrace balená s roštěm		
MAT.VISCO 140	140/196/14		materac dwurdzeniowy, połączenie pianki wysokoelastycznej z pianką termoelastyczną (memory foam), grubość materaca 14 cm, całość obszyta membranową tkaniną materacową , wykończoną obustronnie lamówką	7 230						Matrace balená s roštěm		
MAT.VP.160	160/196/14		materac wykonany z pianki poliuretanowej o grubości 14 cm, obsyty membranową tkaniną materacową , wykończony obustronnie lamówką	3 710						Matrace balená s roštěm		
MAT.HR 160	160/196/14		materac wykonany z pianki wysokoelastycznej o grubości 14 cm, obsyty membranową tkaniną materacową , wykończony obustronnie lamówką	5 990						Matrace balená s roštěm		
MAT.VISCO 160	160/196/14		materac dwurdzeniowy, połączenie pianki wysokoelastycznej z pianką termoelastyczną (memory foam), grubość materaca 14 cm, całość obszyta membranową tkaniną materacową , wykończoną obustronnie lamówką	7 690						Matrace balená s roštěm		

ROZMĚRY (cm)	
hloubka nábytku	97
výška nábytku	107
výška sezení	48
hloubka sezení	57
šířka boku / výška boku	FOT. 16/60, poz. elem. 21/60

ČALOUNĚNÍ	
koordináty	ne
doplňkové prošíání v kůži	ano
omezení tkanin a kůží	tkaniny se vzory
kontrastní prošíání	ne

NOHY	
	
NOHA DŘEVĚNÁ N	NOHA KOVOVÁ CR





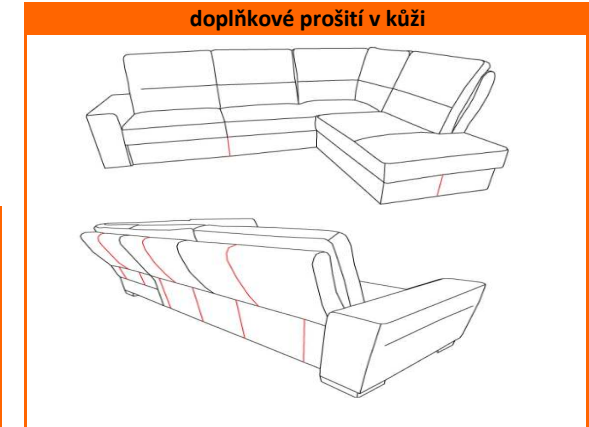



FUNKCE	
funkce spaní	rohovky- delfin, pohovka SOF.3W- rošt
úložný prostor	ano - u rohovek
nastavitelné prvky	FOT.R- obsahuje manuální funkci relax
ostatní	

SLOŽENÍ	
opěrák	směs silikonu a pěny
sedák	pěna vysoce elastická/ lištová pružina





ostatní
<ol style="list-style-type: none"> Nábytek bez koordinátů U kůží je použito doplňkové prošíání V případě tkanin CARABU HT se mohou vyskytnout potíže při rozkládání funkce spaní S ohledem na měkké prvky a způsob očalounění se mohou vyskytnout malé rozdíly v rozměrech nábytku

DAKAR

SYMBOL	ROZMĚRY (š / h / v)		POPIS	CENY								OBJEM (m3)	VÁHA (kg)	MNOŽSTVÍ (ks)	
				A1	A2	B1	B2	B3	B4	S1	S2				
DAKAR NOHA DŘEVĚNÁ	NAR.3W/1OT.N	270x172/97/107		narožník z funkcjã spania typu delfin, pow.spania 122x225, obsahuje úložný prostor, NOHA DŘEVĚNÁ v dostupných barvách N	32 990	34 390	35 330	36 450	38 112	39 571	53 865	58 669	3,85	140	2
	NAR.1OT/3W.N	172x270/97/107		narožník z funkcjã spania typu delfin, pow.spania 122x225, obsahuje úložný prostor, NOHA DŘEVĚNÁ v dostupných barvách N											
	NAR.3W/2OT.N	269x212/97/107		narožník z funkcjã spania typu delfin, pow.spania 122x205, obsahuje úložný prostor, NOHA DŘEVĚNÁ v dostupných barvách N	36 390	37 990	38 990	40 315	42 248	43 977	60 705	66 328	4,15	145	2
	NAR.2OT/3W.N	212x269/97/107		narožník z funkcjã spania typu delfin, pow.spania 122x205, obsahuje úložný prostor, NOHA DŘEVĚNÁ v dostupných barvách N											
	NAR.3W/H/2P.N	270x242/97/107		narožník z funkcjã spania typu delfin, pow.spania 122x205, obsahuje úložný prostor, NOHA DŘEVĚNÁ v dostupných barvách N	39 990	41 790	42 990	44 498	46 745	48 799	63 140	68 557	4,70	200	3
	NAR.2P/H/3W.N	242x270/97/107		narožník z funkcjã spania typu delfin, pow.spania 122x205, obsahuje úložný prostor, NOHA DŘEVĚNÁ v dostupných barvách N											
	SOF.3W.N	200/97/107		pohovka z funkcjã spania, pow.spania 140x190, NOHA DŘEVĚNÁ v dostupných barvách N	21 790	22 690	23 270	23 987	24 990	25 990	34 636	37 731	2,30	110	1
	SOF.3BF.N	200/97/107		pohovka bez funkcji spania, NOHA DŘEVĚNÁ v dostupných barvách N	15 990	16 990	17 590	18 308	19 395	20 333	28 996	31 876	2,30	110	1
	SOF.2BF.N	166/97/107		pohovka bez funkcji spania, NOHA DŘEVĚNÁ v dostupných barvách N	13 990	14 850	15 370	15 990	16 942	17 787	25 742	28 401	1,90	63	1

SYMBOL	ROZMĚRY (š / h / v)	POPIS	CENY								OBJEM (m3)	VÁHA (kg)	MNOŽSTVÍ (ks)		
			A1	A2	B1	B2	B3	B4	S1						
NOHA DŘEVĚNÁ	FOT.R.N	94/97/107		křeslo z funkce relax, NOHA DŘEVĚNÁ v dostupných barvách N	12 350	12 850	13 190	13 643	14 293	14 888	19 990	21 830	1,00	55	1
	FOT.BF.N	94/97/107		křeslo bez funkce, do výběru NOHA DŘEVĚNÁ v dostupných barvách N	9 490	9 990	10 370	10 808	11 486	12 138	17 359	18 894	1,00	44	1
DAKAR NOHA HLINÍKOVÁ	NAR.3W/1OT.CR	270x172/97/107		narožník z funkcí spania typu delfin, pow.spania 122x225, obsahuje úložný prostor, NOHA HLINÍKOVÁ	33 890	34 990	35 990	37 210	38 875	40 343	54 628	59 468	3,85	140	2
	NAR.1OT/3W.CR	172x270/97/107		narožník z funkcí spania typu delfin, pow.spania 122x225, obsahuje úložný prostor, NOHA HLINÍKOVÁ											
	NAR.3W/2OT.CR	269x212/97/107		narožník z funkcí spania typu delfin, pow.spania 122x205, obsahuje úložný prostor, NOHA HLINÍKOVÁ	36 990	38 590	39 690	40 990	42 983	44 702	61 429	66 990	4,15	145	2
	NAR.2OT/3W.CR	212x269/97/107		narožník z funkcí spania typu delfin, pow.spania 122x205, obsahuje úložný prostor, NOHA HLINÍKOVÁ											
	NAR.3W/H/2P.CR	270x242/97/107		narožník z funkcí spania typu delfin, pow.spania 122x205, obsahuje úložný prostor, NOHA HLINÍKOVÁ	39 990	41 990	43 490	44 990	47 322	49 376	63 715	69 134	4,70	200	3
	NAR.2P/H/3W.CR	242x270/97/107		narožník z funkcí spania typu delfin, pow.spania 122x205, obsahuje úložný prostor, NOHA HLINÍKOVÁ											
	SOF.3W.CR	200/97/107		pohovka z funkcí spania, pow.spania 140x190, NOHA HLINÍKOVÁ	22 390	23 290	23 850	24 582	25 660	26 672	35 223	38 336	2,30	110	1
	SOF.3BF.CR	200/97/107		pohovka bez funkce spania, NOHA HLINÍKOVÁ	16 690	17 590	17 990	18 894	19 990	20 920	29 600	32 471	2,30	110	1
	SOF.2BF.CR	166/97/107		pohovka bez funkce spania, NOHA HLINÍKOVÁ	14 690	15 390	15 990	16 580	17 519	18 354	26 309	28 996	1,90	63	1

SYMBOL	ROZMĚRY (š / h / v)		POPIS	CENY								OBJEM (m3)	VÁHA (kg)	MNOŽSTVÍ (ks)
				A1	A2	B1	B2	B3	B4	S1				
FOT.R.CR	94/97/107		křeslo z funkce relax, NOHA HLINÍKOVÁ	12 590	12 990	13 490	13 990	14 712	15 558	20 622	21 990	1,00	55	1
FOT.BF.CR	94/97/107		křeslo bez funkce, do výběru NOHA HLINÍKOVÁ	9 990	10 550	10 990	11 440	12 156	12 797	17 990	18 990	1,00	44	1
DAKAR.MAT.NAR			materacěk tapicerovaný tkaninou, dotyczy narožníka	892	1 152	1 358	1 580	1 933	2 546			netýká se		

ROZMĚRY (cm)	
hloubka nábytku	97
výška nábytku	85
výška sezení	40
hloubka sezení	56
šířka boku / výška boku	25/60

ČALOUNĚNÍ	
koordináty	ano
doplňkové prošíání v kůži	ano
omezení tkanin a kůží	tkaniny se vzory
kontrastní prošíání	ano

NOHY	
	
NOHA DŘEVĚNÁ N	

FUNKCE	
funkce spaní	rošt
úložný prostor	ne
nastavitelné prvky	ne
ostatní	





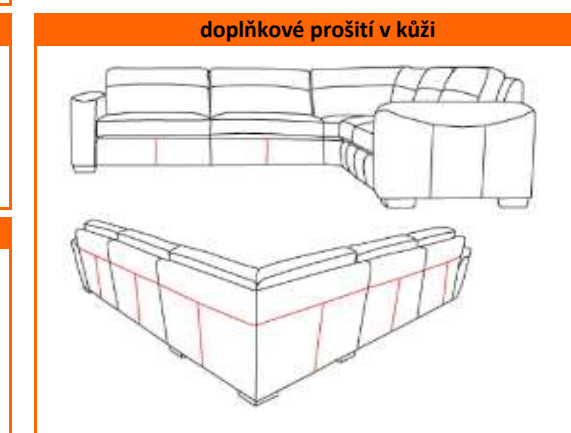





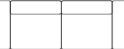
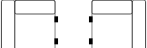

SLOŽENÍ	
opěrák	směs silikonu a pěny
sedák	pěna polyuretanová/ lištová pružina

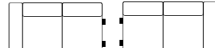
koordináty	
BEZ KOORDINACE	

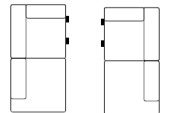

ostatní
<ol style="list-style-type: none"> Kolekce modulová. Nábytek bez koordinace. U kůží je použito doplňkové prošíání. Možnost výběru kontrastní nitě u potahových tkanin: GENUA a u kůží S1, S2. S ohledem na měkké prvky a způsob očalounění se mohou vyskytnout malé rozdíly v rozměrech nábytku. Není možno použít koordináty u nábytku v kůžích.

DAVOS

	ROZMĚRY (š / h / v)		POPIS	CENY								OBJEM (m3)	VÁHA (kg)	MNOŽSTVÍ (ks)
				A1	A2	B1	B2	B3	B4	S1	S2			
FOT.BF	103/97/85		Fotel	7 390	7 990	8 490	9 190	9 990	10 590	13 790	14 490	0,85	41	1
SOF.2BF	175/97/85		Sofa bez funkce	10 890	11 690	12 290	12 990	14 290	14 990	20 990	21 990	1,45	58	1
SOF.2,5S	197/97/85		Sofa z funkcí spania, pow.spania 138x185	16 790	17 590	17 990	18 890	19 990	21 590	27 990	29 390	2,05	75	1
SOF.3BF	225/97/85		Sofa bez funkce	12 990	14 390	14 990	15 790	17 290	17 990	25 990	27 990	1,90	73	1
SEGM.1BF L/P	83/97/85		Element modułowy	6 115	6 525	6 811	7 165	7 695	8 169	11 766	12 453	0,70	30	1
SEGM.2BF L/P	155/97/85		Element modułowy	9 824	10 473	10 957	11 524	12 370	13 132	18 856	20 148	1,30	45	1
SEGM.2P L/P	155/97/85		Element modułowy z pojemnikiem	11 385	12 045	12 527	13 094	13 940	14 702	20 539	21 830	1,35	47	1
SEGM.2,5S L/P	180/97/85		Element modułowy z funkcí spania, pow.spania 138x185	15 622	16 338	16 849	17 472	18 392	20 696	25 762	27 175	1,85	64	1
SEGM.3BF L/P	206/97/85		Element modułowy	12 073	12 852	13 411	14 089	15 241	15 911	24 126	25 781	1,70	58	1
SEGM.2OT L/P	226/100/85		Element modułowy	14 210	15 055	15 650	16 366	17 454	18 420	26 682	28 615	2,00	75	1
SEGM.1BF BB	61/97/85		Element modułowy wewnętrzny	4 749	5 046	5 242	5 484	5 855	6 180	8 875	9 442	0,50	19	1
SEGM.2BF BB	133/97/85		Element modułowy wewnętrzny	8 216	8 744	9 126	9 582	10 279	10 883	15 697	16 887	1,10	35	1
SEGM.2,5S BB	158/97/85		Element modułowy wewnętrzny z funkcí spania, pow.spania 138x186	14 117	14 702	15 120	15 612	16 366	17 026	23 596	25 008	1,65	53	1
SEGM.3BF BB	184/97/85		Element modułowy wewnętrzny	10 697	11 347	11 821	12 370	13 225	13 968	20 121	21 626	1,50	47	1
SEGM.H	103/103/85		Element modułowy narożny	7 370	7 816	8 104	8 429	9 025	9 759	13 494	14 192	0,90	38	1
ZAG.	50/17/19		zagiówek	1 290	1 390	1 450	1 520	1 630	1 670	1 810	1 920	0,05	2	1

ROZMĚRY (cm)	
hloubka nábytku	88
výška nábytku	89
výška sezení	46
hloubka sezení	55
šířka boku / výška boku	24/63

ČALOUNĚNÍ	
koordináty	ano
doplňkové prošití v kůži	ano
omezení tkanin a kůží	tkaniny se vzory
kontrastní prošití	ano

NOHY	
	
NOHA DŘEVĚNÁ N	NOHA KOVOVÁ CR

FUNKCE	
funkce spaní	v SEGM.2W, SEGM.2,5W - delfin, v SOF.2,5S - rošt
úložný prostor	ano - SEGM. 1P, SEGM.2P
nastavitelné prvky	ne
ostatní	

SLOŽENÍ	
sedák	pěna vysoce elastická /polyuretanová/lištová pružina
opěrák	pěna polyuretanová/ potah se směsí silikonu a pěny/ elastický pás

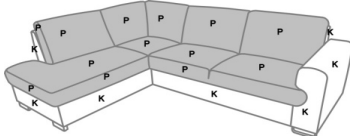

koordináty	
	
P- ZÁKLAD	K- KOORDINÁT

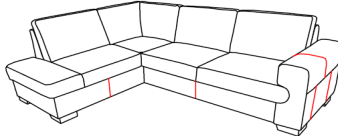
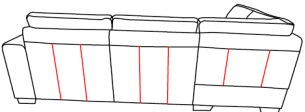
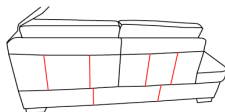













doplňkové prošití v kůži	
	
	















ZPŮSOB ROZKLÁDÁNÍ FUNKCE SPANÍ	
	
ROHOVKA ROZKLÁDÁNÍ TYPU 01 (DELFIN)	POHOVKA ROZKLÁDÁNÍ TYPU 07

ostatní	
<ol style="list-style-type: none"> Nábytek s koordináty V případě tkaniny: CARABU HT se mohou vyskytnout potíže při rozkládání funkce spaní V případě čalounění přírodní kůží se používá doplňkové prošití Možnost výběru kontrastní nitě u potahových tkanin: GENUA, RAJAN, VIENNA a kůžích Uvedené ceny jsou cenami částečnými. Pro získání celkové prodejní ceny je potřeba sečíst jednotlivé prvky sestavy a boky, a to zapsané zleva doprava, jak jdou po sobě S ohledem na měkké prvky a způsob očalounění se mohou vyskytnout malé rozdíly v rozměrech nábytku Správný postup zápisu vybraných prvků na objednávce je jejich postupné uvedení zleva doprava Není možno spojit prvky s různými komforty 	









SYMBOL	ROZMĚRY (š / h / v)		POPIS	CENY								OBJEM (m3)	VÁHA (kg)	MNOŽSTVÍ (ks)
				A1	A2	B1	B2	B3	B4	S1	S2			
FOT.BF /2010 N	100/88/89		křeslo	8 460	8 950	9 290	9 721	10 427	11 143	15 967	17 825	0,85	40	1
SEGM.1BF L 1110/ P 1110 N	78/88/89		moduť	6 924	7 305	7 574	7 899	8 391	9 005	12 305	13 633	0,65	34	1
SEGM.1BF BB /0010 N	56/88/89		moduť	5 167	5 437	5 623	5 845	6 190	6 618	8 643	9 479	0,50	30	1
SOF.2BF /2020 N	176/88/89		pohovka 2-osobowa	12 690	13 380	13 890	14 498	15 400	16 217	23 253	25 724	1,50	51	1
SEGM.2BF L 1120 /P 1220 N	154/88/89		moduť	10 734	11 329	11 746	12 259	13 011	13 782	19 201	21 124	1,30	50	1
SOF.2,5BF 2025 N	196/88/89		pohovka 2-osobowa	13 690	14 490	14 990	15 697	16 681	17 565	24 925	27 518	1,60	59	1
SOF.2,5S 2025S	196/88/89		pohovka 2-osobowa z funkcją spania, pow.spania 131x190	19 990	20 990	21 750	22 508	23 495	24 433	31 783	34 628	1,60	108	1
SEGM.2,5BF L 1125 /P 1225 N	174/88/89		moduť	12 025	12 676	13 132	13 679	14 507	15 259	21 477	23 624	1,45	53	1
SEGM.2,5W L 1125W/P 1225W N	174/88/89		moduť z funkcją spania, może być stosowana wyłącznie przy tworzeniu narożników, pow. spania min.120x200	14 795	15 437	15 892	16 449	17 277	18 011	24 237	26 468	1,45	72	1
SOF.3BF /2030 N	216/88/89		pohovka 3-osobowa	14 390	15 190	15 780	16 468	17 500	18 429	26 384	31 922	1,80	69	1
SEGM.3BF L 1130/P 1230 N	194/88/89		moduť	12 602	13 300	13 792	14 386	15 279	16 086	22 740	25 036	1,60	60	1
SEGM.1P L 5110/P 5210 N	175/98/89		moduť z pojemnikiem	12 444	13 048	13 475	13 996	14 767	15 465	21 413	23 521	1,60	63	1
SEGM.2P L 5120 /P 5220 N	196/85/89		moduť z pojemnikiem	14 395	15 112	15 612	16 227	17 137	17 973	23 680	25 817	1,60	67	1

EGO
NOHA DŘEVĚNÁ N

SYMBOL	ROZMĚRY (š / h / v)	POPIS	CENY										OBJEM (m3)	VÁHA (kg)	MNOŽSTVÍ (ks)
			A1	A2	B1	B2	B3	B4	S1	S2					
EGO NOHA DŘEVĚNÁ N	SEGM.1M L 3110/P 3210 N	112/88/89		moduť	7 453	7 844	8 131	8 504	9 107	9 767	13 039	14 349	0,90	32	1
	SEGM.2M L 4110/P 4210 N	170/98/89		moduť z pojemníkem	13 346	14 014	14 488	15 055	15 911	16 691	22 992	25 242	1,60	69	1
	SEGM.H / 7010 N	85/85/89		moduť	7 798	8 226	8 532	8 904	9 452	10 185	12 899	13 950	0,70	31	1
	STS. / 8385 N	85/85/42		stolik wolnostojący z szybą	4 520	4 810	4 990	5 242	5 605	5 930	7 945	8 912	0,30	36	1
	STS.H/ 8385H N	85/85/42		moduť/ stolik prostopadle łączący dwa elementy	4 520	4 810	4 990	5 242	5 605	5 930	7 945	8 912			
	STS.I / 8385 N	85/85/42		moduť/ stolik z szybą równolegle łączący dwa elementy											
	PUF.P 90x90 / 8190 N	90/90/46		pufa z pojemníkem	4 540	4 840	4 990	5 316	5 698	6 291	8 066	9 061	0,40	36	1
	PUF.P 60x60 / 8160 N	60/60/46		pufa z pojemníkem	2 990	3 260	3 410	3 587	3 876	4 219	4 879	5 446	0,20	22	1
NOHA KOVOVÁ CR	FOT.BF /2010 CR	100/88/89		křeslo	9 390	9 790	9 990	10 594	11 226	11 785	16 841	18 735	0,85	40	1
	SEGM.1BF L 1110/ P 1110 CR	78/88/89		moduť	7 352	7 732	8 002	8 327	8 819	9 293	12 741	14 079	0,65	34	1
	SEGM.1BF BB /0010 CR	56/88/89		moduť	5 167	5 437	5 623	5 845	6 190	6 618	8 643	9 479	0,50	30	1
	SOF.2BF /2020 CR	176/88/89		pohovka 2-osobowa	13 560	14 290	14 690	15 372	16 274	17 091	23 345	26 636	1,50	51	1
	SEGM.2BF L 1120 /P 1220 CR	154/88/89		moduť	10 990	11 750	11 990	12 686	13 447	14 135	19 627	21 580	1,30	50	1
	SOF.2,5BF 2025 CR	196/88/89		pohovka 2-osobowa	14 690	15 490	15 990	16 681	17 666	18 550	25 910	28 569	1,60	59	1

SYMBOL	ROZMĚRY (š / h / v)	POPIS	CENY										OBJEM (m3)	VÁHA (kg)	MNOŽSTVÍ (ks)
			A1	A2	B1	B2	B3	B4	S1	S2					
SOF.2,5S 2025S CR	196/88/89		pohovka 2-osobowa z funkcją spania, pow.spania 131x190	20 990	21 850	22 390	23 057	24 042	24 962	32 314	35 176	1,60	108	1	
SEGM.2,5BF L 1125 /P 1225 CR	174/88/89		moduł	12 450	12 990	13 570	14 127	14 952	15 707	21 923	24 088	1,45	53	1	
SEGM.2,5W L 1125W/P 1225W CR	174/88/89		moduł z funkcją spania, może być stosowana wyłącznie przy tworzeniu narożników, pow. spania min.120x200	15 241	15 882	16 338	16 895	17 722	18 457	24 683	26 933	1,45	72	1	
SOF.3BF /2030 CR	216/88/89		pohovka 3-osobowa	15 290	15 990	16 650	17 341	18 374	19 302	27 258	30 056	1,80	69	1	
SEGM.3BF L 1130/P 1230 CR	194/88/89		moduł	13 048	13 746	14 238	14 833	15 725	16 534	23 188	25 502	1,60	60	1	
SEGM.1P L 5110/P 5210 CR	175/98/89		moduł z pojemnikiem	13 253	13 857	14 284	14 795	15 576	16 274	22 212	24 441	1,60	63	1	
SEGM.2P L 5120 /P 5220 CR	196/85/89		moduł z pojemnikiem	15 287	15 993	16 506	17 109	18 021	18 856	24 562	26 755	1,60	67	1	
SEGM.1M L 3110/P 3210 CR	112/88/89		moduł	7 899	8 290	8 579	8 912	9 424	10 056	13 485	14 813	1,00	32	1	
SEGM.2M L 4110/P 4210 CR	170/98/89		moduł z pojemnikiem	14 117	14 888	15 362	15 929	16 784	17 565	23 866	26 162	1,60	69	1	
SEGM.H / 7010 CR	85/85/89		moduł	8 661	9 089	9 396	9 759	10 306	10 808	13 764	14 860	0,70	31	1	
STS. / 8385 CR	85/85/42		stolik wolnostojący	5 160	5 490	5 740	5 990	6 450	6 775	8 792	9 795	0,30	36	1	
STS.H/ 8385H CR	85/85/42		moduł/ stolik z szybą prostopadle łączący dwa elementy	5 160	5 490	5 740	5 990	6 450	6 775	8 792	9 795				
STS.I / 8385 CR	85/85/42		moduł/ stolik z szybą równolegle łączący dwa elementy												
PUF.P 90x90 /8190 CR	90/90/46		pufa z pojemnikiem	5 430	5 730	5 950	6 208	6 589	6 933	8 958	9 973	0,40	36	1	

EGO
NOHA KOVOVÁ CR

SYMBOL	ROZMĚRY (š / h / v)		POPIS	CENY								OBJEM (m3)	VÁHA (kg)	MNOŽSTVÍ (ks)
				A1	A2	B1	B2	B3	B4	S1	S2			
PUF.P 60x60 / 8160 CR	60/60/46		pufa z pojemníkem	3 930	4 130	4 280	4 461	4 777	4 953	5 762	6 357	0,20	22	1
SEGM.2BF BB / 0020	132/88/89		moduľ	9 378	9 898	10 269	10 715	11 393	11 998	15 939	17 426	1,10	40	1
SEGM.2W BB / 0020W	132/88/89		moduľ z funkcí spania, moze byť stosowana wyłacznie przy tworzeniu narożników, pow.spania min 120x187	12 128	12 648	13 020	13 475	14 145	14 759	18 727	20 297	1,10	56	1
SEGM.2,5BF BB / 0025	152/88/89		moduľ	10 492	11 153	11 645	12 221	13 076	13 838	18 485	20 186	1,25	47	1
SEGM.2,5W BB / 0025W	152/88/89		moduľ z funkcí spania, moze byť stosowana wyłacznie przy tworzeniu narożników, pow.spania min 120x187	13 475	14 042	14 460	14 944	15 687	16 347	20 781	22 528	1,25	59	1
SEGM.3BF BB / 0030	172/88/89		moduľ	11 226	11 886	12 332	12 872	13 671	14 405	19 470	21 310	1,45	55	1
ZAG.M /9010	50/15/19		zagliwek rekomendowany do wszystkich elementůw	1 290	1 390	1 450	1 523	1 636	1 673	1 794	1 961	0,05	2	1
ZAG.D /9020	70/15/19		zagliwek rekomendowany do wybranych elementůw: 2,5; 3 a wszystkich szezlongůw	1 340	1 450	1 530	1 626	1 775	1 858	2 026	2 240	0,05	2	1
SEGM.BOX,TAP /8485	44/88/60		moduľ, wystepujacy wyłacznie jako łacznicz dwůch elementůw, obsahuje wewnętrznę półkę	4 777	5 056	5 242	5 492	5 855	6 180	8 885	9 117			
EGO.MAT			matęracyk tapicerowany tkaniną, dotyczy segmentůw z funkcí spania	902	1 170	1 366	1 598	1 951	2 574			netýká se		

FOCUS - ostatní látky**MOC s DPH**

	ROZMĚRY (š / h / v)	POPIS	A1	A2	B1	B2	B3	B4	S1
NAR.3W/2OT	255x195/98/95-104	rohovka s funkcí spaní a úl. prost., plocha spaní 120x198	24 990	26 790	27 990	28 990	30 990	32 990	42 490
NAR.2OT/3W	255x195/98/95-104		24 990	26 790	27 990	28 990	30 990	32 990	42 490
FOT.BF	84/98/92-103	křeslo	7 450	7 990	8 490	8 990	9 690	10 390	13 690
MAT		matrace	930	1 280	1 520	1 830	2 270	2 680	

1. Nábytek bez koordinátů.
2. Nábytek není dostupný ve tkaninách se vzory.
3. V případě tkaniny CARABU HP se mohou vyskytnout potíže při rozkládání funkce spaní.

ROZMĚRY (cm)	
hloubka nábytku	105
výška nábytku	90
výška sezení	45
hloubka sezení	60
šířka boku / výška boku	BOK A- 23, BOK B- 13

FUNKCE	
funkce spaní	Leopard: SEG.2R L/P, SEG.2R BB
úložný prostor	ne
nastavitelné prvky	ne
ostatní	



ČALOUNĚNÍ	
KOORDINÁTY	týká se pouze polštářku POD.11
DOPLŇKOVÉ PROŠITÍ V KŮŽI	ne
omezení tkanin a kůží	kůže - dostupné vybrané prvky
kontrastní prošití	ne

SLOŽENÍ	
opěrák	lištová pružina, pěna vysoce elastická, potah se silikonovým peřím
sedák	volné opěrné polštářky vyplněné směsí silikonu

NOHY	
NE - PRVKY USAZENÉ NA NÁBYTKOVÝCH NOŽKÁCH - 3CM	

KOORDINÁTY	
NE	

DOPLŇKOVÉ PROŠITÍ V KŮŽI	
NE	

ZPŮSOB ROZKLÁDÁNÍ FUNKCE SPANÍ

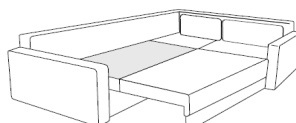
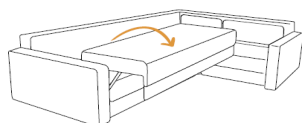











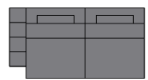
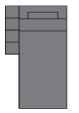



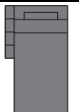



ROHOVKA - ROZKLÁDÁNÍ TYPU 03 (LEOPARD)

ostatní

1. Kolečka modulová, prvky kolečky jsou spojené pomocí "krokodýlů".
2. V případě tkaniny: CARABU HP se mohou vyskytnout potíže při rozkládání funkce spaní.
3. Některé prvky kolečky mohou být z vybrané sestavy a vytvářet tak samostatný kus nábytku, což umožňuje zaranžovat místnost dle potřeb jejího uživatele (netýká se prvku SEG.2R L/P a SEG.2RBB).
4. Uvedené ceny jsou cenami částečnými. Pro získání celkové prodejní ceny je potřeba sečíst jednotlivé prvky sestavy a boky, a to zapsané zleva doprava, jak jdou po sobě.
5. S ohledem na měkké prvky a způsob očalounění se mohou vyskytnout malé rozdíly v rozměrech nábytku.
6. Správný postup zápisu vybraných prvků na objednávce je jejich postupné uvedení zleva doprava.
7. V případě koordinace kůže a tkaniny u polštářku POD.12 je nemožné spojení kůže s tkaninou MELA.
8. Prvky kolečky: PUF.BF 50X105, POD.09, POD.11, POD.12, POD.STK mohou být vyrobeny v přírodní kůži.
9. Stolek STK. obsahuje dýhovanou desku.

GRANDE

SYMBOL	ROZMĚRY (š / h / v)		POPIS	CENA								OBJEM (m3)	VÁHA (kg)	MNOŽSTVÍ (ks)
				A1	A2	B1	B2	B3	B4	S1	S2			
FOT.BF A	126/105/90		Fotel z bokami A	10 590	11 390	11 990	12 590	13 590	14 390			0,8	32	1
SEG.1BF A L/P	103/105/90		Element modułowy z bokiem A	9 051	9 646	10 066	10 558	11 310	11 979			0,7	30	1
SEG.2R A L/P	183/105/90		Element modułowy z funkcją spania, z bokiem A, pow. spania min. 160 x240	18 540	19 488	20 158	20 957	21 915	23 243			1,25	87	1
SEG.1OT A L/P	185/103/90		Otomana z bokiem A	11 700	12 434	12 955	13 587	14 526	15 354			1,25	56	1
FOT.BF B	106/105/90		Fotel z bokami B	10 590	11 390	11 990	12 590	13 590	14 390			0,8	32	1
SEG.1BF B L/P	93/105/90		Element modułowy z bokiem B	9 051	9 646	10 066	10 558	11 310	11 979			0,7	30	1
SEG.2R B L/P	173/105/90		Element modułowy z funkcją spania, z bokiem B, pow. spania min. 160 x240	18 540	19 488	20 158	20 957	21 915	23 243			1,25	87	1
SEG.1OT B L/P	185/93/90		Otomana z bokiem B	11 700	12 434	12 955	13 587	14 526	15 354			1,25	56	1
SEG.1BF BB	80/105/90		Element modułowy bez boków	7 435	7 853	8 151	8 522	9 051	9 525			0,6	29	1
SEG.2R BB	160/105/90		Element modułowy bez boków, z funkcją spania, pow. spania min.160 x 320, dedykowany układom narożnym	18 531	19 302	19 861	20 511	21 514	22 397			1,1	67	1
SEG.H	105/105/90		Element narożny	9 935	10 705	11 264	11 914	12 918	13 800			0,7	38	1

SYMBOL	ROZMĚRY (š / h / v)		POPIS	CENA								OBJEM (m3)	VÁHA (kg)	MNOŽSTVÍ (ks)
				A1	A2	B1	B2	B3	B4	S1	S2			
SEG.1HT L/P	120/105/90		Element modułowy	9 136	9 618	9 945	10 362	10 966	11 514			0,8	41	1
PUF.BF 50X105	52/105/45		Pufa, możliwość wykonania w skórze	3 990	4 210	4 350	4 510	4 760	4 980	5 510	5 760	0,2	25	1
PUF.BF 80X80	82/82/45		Pufa	3 850	4 070	4 210	4 390	4 660	4 890			0,3	26	1
STK.	52/105/90		Stolik z fornirowanym blatem w kolorze orzecha i dębu	2 210	2 340	2 420	2 520	2 670	2 810			0,2	23	1
POD.STK	52/105/17		Poduszka na stolik STK.	2 280	2 460	2 590	2 740	2 970	3 170	5 010	5 430	0,15	4	1
POD.09	45/45/10		Poduszka dekoracyjna	810	880	930	980	1 050	1 130	1 450	1 550	0,03	0,5	1
POD.11	45/45/10		Poduszka dekoracyjna	980	1 050	1 090	1 160	1 260	1 330	1 680	1 790	0,03	0,5	1
POD.12	45/45/10		Poduszka dekoracyjna	1 210	1 320	1 410	1 530	1 680	1 820	2 430	2 630	0,03	0,5	1
POD.10	FI 16/50		Poduszka dekoracyjna	900	950	1 010	1 050	1 130	1 210	2 240	2 450	0,02	0,5	1
MAT.3	Materacyk tapicerowany tkaniną właściwa mebla			874	1 227	1 469	1 765	2 211	2 621			nie dotyczy		

ROZMĚRY (cm)		FUNKCE	
hloubka nábytku	100/109	funkce spaní	delfin
výška nábytku	84/100	úložný prostor	v SEGM.1HT a SEGM.1OT
výška sezení	47	nastavitelné prvky	nastavitelné záhlavky
hloubka sezení	58	ostatní	funkce relax
šířka boku / výška boku	25/64		

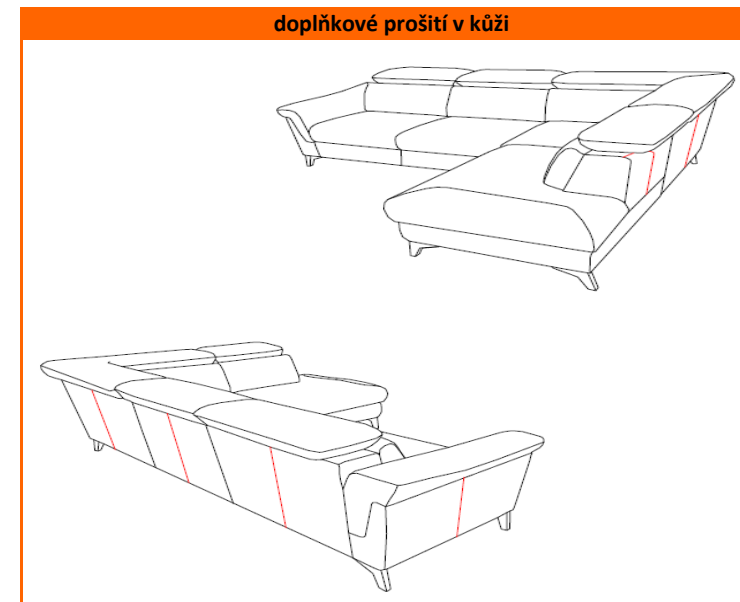

ČALOUNĚNÍ		SLOŽENÍ	
koordináty	ne	sedák	lištová pružina, pěna vysoce elastická
doplňkové prošíání v kůži	ano - záda korpusu	opěrák	čalounický pás, pěna polyuretanová
omezení tkanin a kůží	tkaniny se vzory		
kontrastní prošíání	ne		

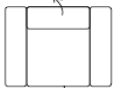
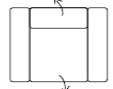
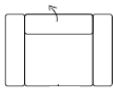
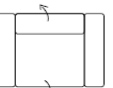
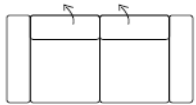
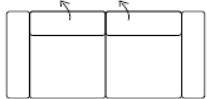
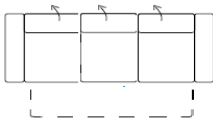
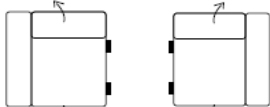
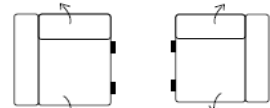
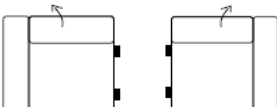
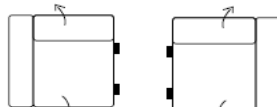

- ostatní**
1. V případě tkaniny CARABU HT se mohou vyskytnout potíže s polohováním nastavitelných prvků a funkce spaní.
 2. U kůží je použito doplňkové prošíání.
 3. Nohy a doplňkové prvky dřevěné dostupné v 10 barvách
 4. Uvedené ceny jsou cenami částečnými. Pro získání celkové prodejní ceny je potřeba sečíst jednotlivé prvky sestavy, a to zapsané zleva doprava, jak jdou po sobě.
 5. S ohledem na měkké prvky a způsob očalounění se mohou vyskytnout malé rozdíly v rozměrech nábytku.

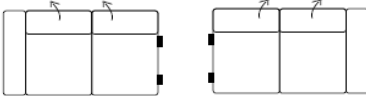
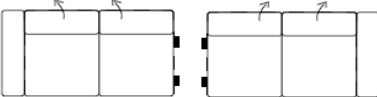
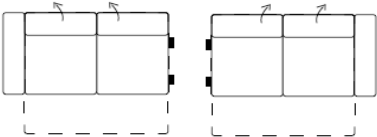
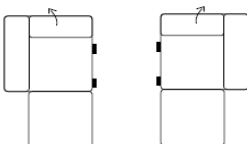
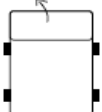
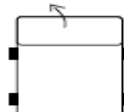
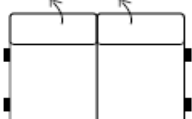
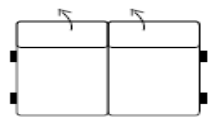
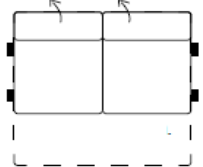
SYMBOL	ROZMĚRY (š / h / v)	POPIS	CENA								OBJEM (m3)	VÁHA (kg)	MNOŽSTVÍ (ks)	
			A1	A2	B1	B2	B3	B4	S1	S2				
FOT.BF	112/100-109/84-100		Fotel	12 490	12 990	13 790	14 290	14 990	15 990	21 290	22 990	1,03	42	1
FOT.RE	112/100-109/84-100		Fotel z funkcją relaks	20 990	21 790	22 290	22 990	23 990	24 790	29 990	31 890	1,03	65	1
SOF.1,5BF	127/100-109/84-100		Fotel	13 490	14 290	14 790	15 490	16 390	17 290	22 790	24 590	1,16	52	1
SOF.1,5RE	127/100-109/84-100		Fotel z funkcją relaks	21 990	22 890	23 390	23 990	24 990	25 990	31 590	33 490	1,16	69	1
SOF.2BF	179/100-109/84-100		Sofa	15 990	16 990	17 790	18 590	19 790	20 890	27 790	29 990	1,64	72	1
SOF.3BF	204/100-109/84-100		Sofa	17 690	18 590	19 390	20 290	21 590	22 790	29 990	32 490	1,87	75	1
SOF.3,5W	236/100-109/84-100		Sofa z funkcją spania	25 990	26 990	27 990	28 990	30 390	31 790	37 290	39 990	1,87	91	1
SEGM.1BF L/P	89/100-109/84-100		Element modułowy	9 228	9 759	10 120	10 566	11 236	11 831	15 576	16 738	0,81	40	1
SEGM.1RE L/P	89/100-109/84-100		Element modułowy z funkcją relaks, brak możliwości łączenia z elementami z funkcją spania	17 741	18 318	18 717	19 209	19 934	20 575	24 358	25 660	0,81	60	1
SEGM.1,5BF L/P	103/100-109/84-100		Element modułowy	10 241	10 808	11 208	11 692	12 426	13 066	17 063	18 318	0,94	45	1
SEGM.1,5RE L/P	103/100-109/84-100		Element modułowy z funkcją relaks, brak możliwości łączenia z elementami z funkcją spania	18 745	19 349	19 795	20 315	21 106	21 802	25 902	27 304	0,94	65	1

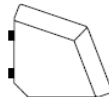
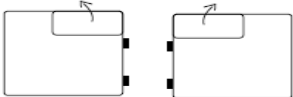
SYMBOL	ROZMĚRY (š / h / v)	POPIS	CENA								OBJEM (m3)	VÁHA (kg)	MNOŽSTVÍ (ks)	
			A1	A2	B1	B2	B3	B4	S1	S2				
SEGM.2BF L/P	153/100-109/84-100		Element modułowy	12 862	13 633	14 182	14 841	15 826	16 700	22 081	23 791	1,4	69	1
SEGM.3BF L/P	178/100-109/84-100		Element modułowy	14 359	15 204	15 808	16 542	17 630	18 606	24 516	26 366	1,63	71	1
SEGM.3W L/P	178/100-109/84-100		Element modułowy z funkcją spania, pow.spania 190x120, dedykowany układom narożnym	17 333	18 215	18 846	19 601	20 743	21 756	27 843	29 795	1,6	75	1
SEGM.10T L/P	108/169-179/84-100		Element modułowy/otomana z pojemnikiem	17 454	18 160	18 671	19 274	20 186	20 995	26 023	27 695	1,78	68	1
SEGM.1BF BB	64/100-109/84-100		Element modułowy wewnętrzny	5 938	6 283	6 533	6 821	7 267	7 649	9 935	10 604	0,59	26	1
SEGM.1,5 BB	78/100-109/84-100		Element modułowy wewnętrzny	6 942	7 332	7 612	7 945	8 438	8 885	11 440	12 184	0,71	32	1
SEGM.2BF BB	128/100-109/84-100		Element modułowy wewnętrzny	9 582	10 158	10 594	11 097	11 859	12 527	16 459	17 658	1,17	59	1
SEGM.3BF BB	154/100-109/84-100		Element modułowy wewnętrzny	11 068	11 738	12 221	12 806	13 661	14 434	18 828	20 176	1,41	61	1
SEGM.3W BB	154/100-109/84-100		Element modułowy wewnętrzny z funkcją spania, pow. Spania min.190x120, dedykowany jedynie układom narożnym	14 042	14 749	15 259	15 864	16 774	17 583	22 155	23 596	1,41	70	1

SYMBOL	ROZMĚRY (š / h / v)	POPIS	CENA								OBJEM (m3)	VÁHA (kg)	MNOŽSTVÍ (ks)	
			A1	A2	B1	B2	B3	B4	S1	S2				
SEGM.H1	109/109/84		Element modułowy narożny, brak możliwości bezpośredniego łączenia z elementami z funkcją relaks	8 522	9 136	9 572	10 102	10 883	11 589	15 612	16 774	1	38	1
SEGM.H2	142/142/84		Element modułowy narożny, brak możliwości łączenia z elementami z funkcją spania	11 087	12 035	12 705	13 512	14 720	15 808	22 119	24 005	1,62	45	1
SEGM.1HT L/P	100-109/103/84-100		Element modułowy z pojemnikiem	11 506	12 035	12 416	12 862	13 550	14 153	17 872	19 034	0,93	37	1
PUF.BF	65/65/47		Puf z pojemnikiem	3 650	3 890	4 060	4 250	4 560	4 840	6 450	7 060	0,17	15	1

MAT.3	materacyk tapicerowany tkaniną właściwą mebla			902	1 170	1 366	1 598	1 951	2 574			NETÝKÁ SE		
-------	---	--	--	-----	-------	-------	-------	-------	-------	--	--	-----------	--	--

AKU.	akumulator			5 242								NETÝKÁ SE		
------	------------	--	--	-------	--	--	--	--	--	--	--	-----------	--	--

				CENA										
				A1	A2	B1	B2	B3	B4	S1	S2			
				47 270	49 690	51 440	53 510	56 640	59 410	75 820	80 940			
SEGM.1,5RE L + SEGM.1BF BB + SEGM.H2 + SEGM.1HT P				POSIADA FUNKCJĘ RELAX										

				CENA										
				A1	A2	B1	B2	B3	B4	S1	S2			
				51 520	53 990	55 910	58 100	61 390	64 320	81 660	87 090			
SEGM.1OT L + SEGM.3WBB + SEGM.H1 + SEGM.1HT P				POSIADA FUNKCJĘ SPANIA ORAZ POJEMNIK										

				CENA										
				A1	A2	B1	B2	B3	B4	S1	S2			
				66 270	69 650	72 070	74 960	79 290	83 140	105 540	112 440			
SEGM.1RE L + SEGM.1BF BB + SEGM.H1 + SEGM.3W BB + SEGM.H1 + SEGM.1HT P				POSIADA FUNKCJĘ SPANIA ORAZ POJEMNIK										

ROZMĚRY (cm)	
hloubka nábytku	91
výška nábytku	85-105
výška sezení	48
hloubka sezení	57
šířka boku / výška boku	33/52

ČALOUNĚNÍ	
koordináty	ano
doplňkové prošití v kůži	ano
omezení tkanin a kůží	tkaniny se vzory
kontrastní prošití	ne







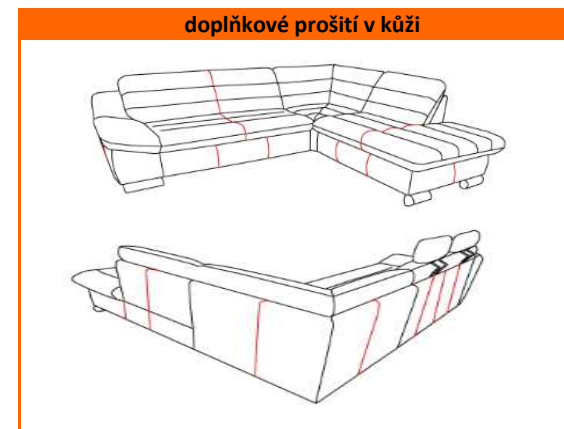
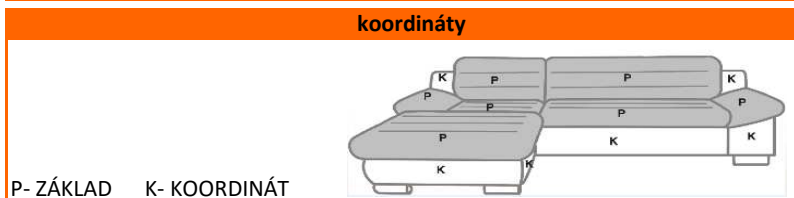

FUNKCE	
funkce spaní	delfin
úložný prostor	ano - 1OT, 2OT
nastavitelné prvky	ne
ostatní	záhlavky - volitelně

SLOŽENÍ	
opěrák	pěna polyuretanová/ elastický pás
sedák	pěna polyuretanová/ lištová pružina



- | ostatní | |
|---|--|
| <ol style="list-style-type: none"> Nábytek s koordináty U kůží je použito doplňkové prošití S ohledem na měkké prvky a způsob očalounění se mohou vyskytnout malé rozdíly v rozměrech nábytku V případě tkaniny CARABU HT se mohou vyskytnout potíže s polohováním nastavitelných prvků a funkce spaní. | |

HORN

SYMBOL	ROZMĚRY (š / h / v)		POPIS	CENY								OBJEM (m3)	VÁHA (kg)	MINOZSTVÍ (ks)
				A1	A2	B1	B2	B3	B4	S1	S2			
HORN	NAR.3W/1OT	289x170/91/85-105	 narožník z funkcí spania, pow.spania 125x215, obsahuje úložný prostor, možnost montáže zagłówka	29 390	30 590	31 490	32 443	33 930	35 231	47 861	53 401	3,00	135	2
	NAR.1OT/3W	170x289/91/85-105	 narožník z funkcí spania, pow.spania 125x215, obsahuje úložný prostor, možnost montáže zagłówka											
	NAR.3W/2OT	273x222/91/85-105	 narožník z funkcí spania, pow.spania 125x205, obsahuje úložný prostor, možnost montáže zagłówka	31 990	33 550	34 490	35 687	37 434	38 968	53 206	59 450	3,10	139	2
	NAR.2OT/3W	222x273/91/85-105	 narožník z funkcí spania, pow.spania 125x205, obsahuje úložný prostor, možnost montáže zagłówka											
	PUF.P	81/106/48	 pufa z pojemníkem	7 720	7 990	8 350	8 671	9 164	9 963	11 208	11 914	0,45	27	1
	ZAG.	55x10x20	 montáž we wszystkich przeznaczonych do tego miejscach, obsahuje funkcí regulacji	950	1 030	1 090	1 152	1 283	1 366	1 422	1 533	0,05	1,5	1
	HORN.MAT			materacyk tapicerowany tkaniną	892	1 152	1 358	1 580	1 933	2 546			netýká se	

ROZMĚRY (cm)	
hloubka nábytku	84
výška nábytku	88
výška sezení	41
hloubka sezení	55
šířka boku / výška boku	40

ČALOUNĚNÍ	
koordináty	ne
doplňkové prošití v kůži	ano
omezení tkanin a kůží	ne
kontrastní prošití	ne

NOHY	
	
NOHY DŘEVĚNÉ	NOHY KOVOVÉ

ZPŮSOB ROZKLÁDÁNÍ FUNKCE SPANÍ	
netýká se	



ostatní	
1. Nábytek bez koordinátů 2. S ohledem na měkké prvky a způsob očalounění se mohou vyskytnout malé rozdíly v rozměrech nábytku	

FUNKCE	
funkce spaní	netýká se
úložný prostor	netýká se
nastavitelné prvky	netýká se
ostatní	

SLOŽENÍ	
opěrák	pěna polyuretanová/ elastický pás
sedák	pěna polyuretanová/ lištová pružina







doplňkové prošití v kůži
netýká se

SYMBOL	ROZMĚRY (š / h / v)		POPIS	CENY								OBJEM (m3)	VÁHA (kg)	MNOŽSTVÍ (ks)
				A1	A2	B1	B2	B3	B4	S1	S2			
JIM	FOT.BF N	70/84/88	 křeslo z dřevnianými nogami	6 290	6 590	6 840	7 118	7 538	7 899	11 775	13 726	0,50	24,5	1
	FOT.BF CR	70/84/88	 křeslo z metalowými nogami	6 750	7 120	7 390	7 732	8 226	8 345	12 202	14 153	0,50	24,5	1
	ZAG.	40/10/19	 zagtówek	1 210	1 280	1 320	1 384	1 422	1 441	1 608	1 729	0,05	1,5	1

ROZMĚRY (cm)	
hloubka nábytku	98
výška nábytku	87-101
výška sezení	47
hloubka sezení	55
šířka boku / výška boku	22/60

ČALOUNĚNÍ	
koordináty	ne
doplňkové prošití v kůži	ano
omezení tkanin a kůží	tkaniny se vzory
kontrastní prošití	ne

NOHY			
			
NOHA DŘEVĚNÁ N	NOHA KOVOVÁ CR	NOHA KOVOVÁ CR1	NOHA KOVOVÁ CR2



ZPŮSOB ROZKLÁDÁNÍ FUNKCE SPANÍ			
			
ROZKLÁDÁNÍ TYPU 04 (LEOPARD)			

ostatní
<ol style="list-style-type: none"> 1. V případě tkanin: CARABU HT se mohou vyskytnout potíže při rozkládání funkce spaní 2. U kůží je použito doplňkové prošití 3. Nohy dřevěné dostupné v 10 barvách 4. Uvedené ceny jsou cenami částečnými. Pro získání celkové prodejní ceny je potřeba sečíst jednotlivé prvky sestavy a boky, a to zapsané zleva doprava, jak jdou po sobě 5. S ohledem na měkké prvky a způsob očalounění se mohou vyskytnout malé rozdíly v rozměrech nábytku 6. Správný postup zápisu vybraných prvků na objednávce je jejich postupné uvedení zleva doprava

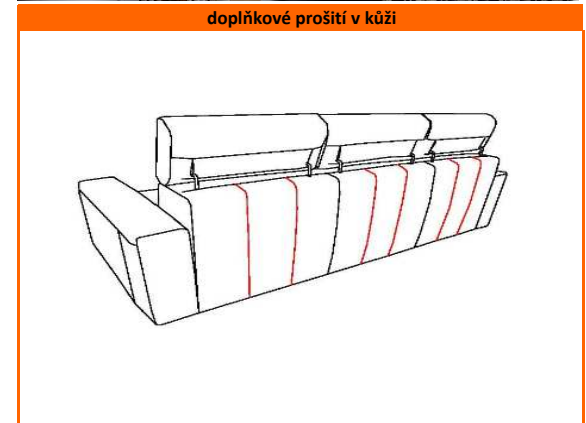

FUNKCE	
funkce spaní	LEOPARD
úložný prostor	ano - SEGM.2P, SEGM.1OT
nastavitelné prvky	nastavitelný záhlavek
ostatní	

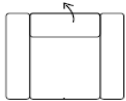
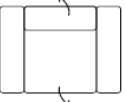
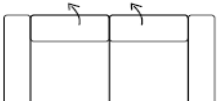
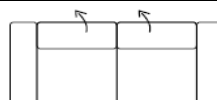
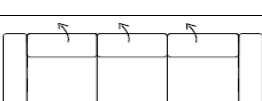
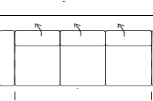

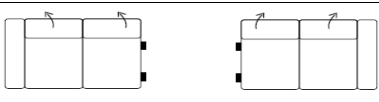
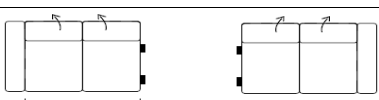
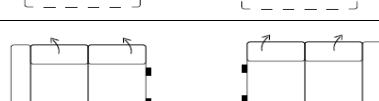

SLOŽENÍ	
opěrák	pěna polyuretanová
sedák	pěna vysoce elastická/ lištová pružina

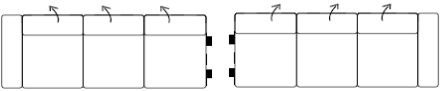
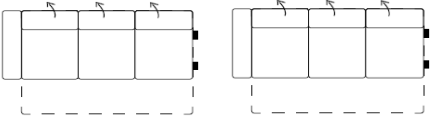
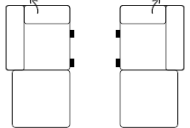
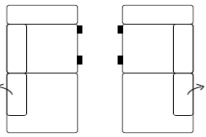

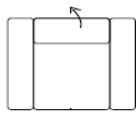
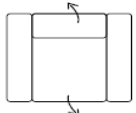
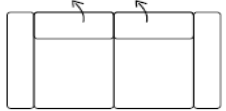
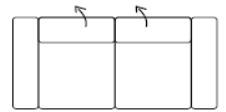

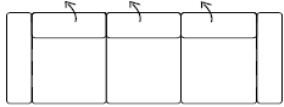
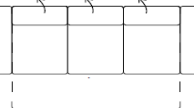
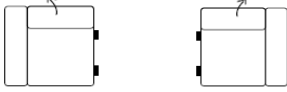

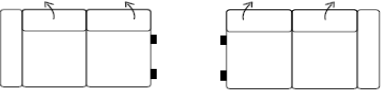
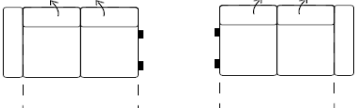
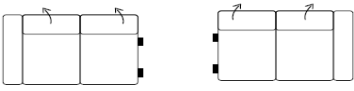
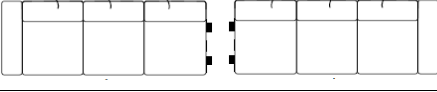
SYMBOL	ROZMĚRY (š / h / v)	POPIS	CENY										OBJEM (m3)	VÁHA (kg)	MNOŽSTVÍ (ks)
			A1	A2	B1	B2	B3	B4	S1	S2					
FOT.BF N/CR		96/98/87-101 Fotel	7 990	8 490	8 890	9 290	9 990	10 990	14 990	17 290	0,80	42	1		
FOT.RE N/CR		96/98/87-101 Fotel z funkcją relaks	18 990	19 590	19 990	20 490	21 490	22 690	26 990	29 490	0,80	64	1		
SOF.2BF N/CR		176/98/87-101 Sofa	12 790	13 490	13 990	14 590	15 590	17 390	24 990	28 490	1,40	73	1		
SOF.2P N/CR		176/98/87-101 Sofa	14 590	15 290	15 790	16 490	17 390	18 990	26 390	29 590	1,40	68	1		
SOF.3BF N/CR		228/98/87-101 Sofa	16 490	17 390	17 990	18 790	19 990	22 390	30 990	35 490	1,90	91	1		
SOF.3R N/CR		228/98/87-101 Sofa z funkcją spania, pow.spania 138x240	21 990	22 990	23 990	24 790	25 990	28 390	36 590	41 390	1,90	105	1		
SEGM.1BF L/P N/CR		78/98/87-101 Element modułowy	6 579	6 924	7 175	7 471	7 927	8 857	12 285	13 931	0,65	30	1		
SEGM.1RE L/P N/CR		78/98/87-101 Element modułowy z funkcją relaks, brak możliwości łączenia z elementami z funkcją spania oraz elementem narożnym	16 812	17 286	17 565	17 993	18 568	19 098	22 686	23 931	0,65	62	1		
SEGM.2BF L/P N/CR		158/98/87-101 Element modułowy	11 254	11 859	12 285	12 426	13 568	14 962	22 202	25 260	1,30	61	1		
SEGM.2R L/P N/CR		158/98/87-101 Element modułowy z funkcją spania, może być stosowany wyłącznie przy budowie narożników, pow. spania 138x195	15 892	16 589	17 091	17 694	18 596	20 214	26 245	29 303	1,30	64	1		
SEGM.2P L/P N/CR		158/98/87-101 Element modułowy z pojemnikiem	12 453	13 066	13 532	14 032	14 888	16 506	23 141	26 180	1,30	56	1		

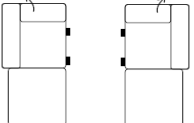
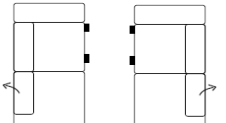
PRVKY S NOHOU N NEBO CR



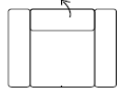
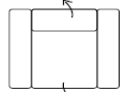

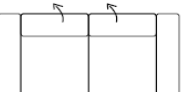
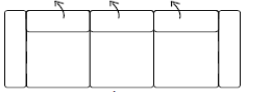
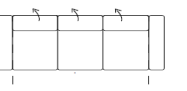
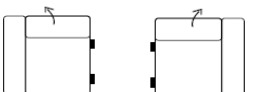
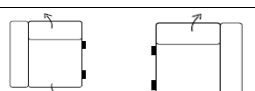
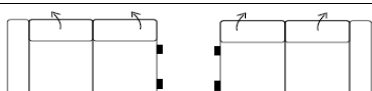
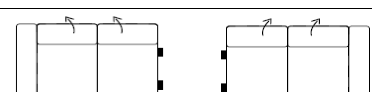

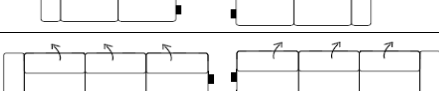
SYMBOL	ROZMĚRY (š / h / v)	POPIS	CENY										OBJEM (m3)	VÁHA (kg)	MNOŽSTVÍ (ks)
			A1	A2	B1	B2	B3	B4	S1	S2					
PRVKY S NOHOU N NEBO CR	SEGM.3BF L/P N/CR		210/98/87-101	Element modułowy	15 780	16 570	17 137	17 815	18 828	20 594	28 726	32 723	1,80	79	1
	SEGM.3R L/P N/CR		210/98/87-101	Element modułowy z funkcją spania, może być stosowany wyłącznie przy budowie narożników, pow. spania 138x240	20 753	21 691	22 444	23 178	24 255	25 482	34 497	39 070	1,80	90	1
	SEGM.1OT L/P N/CR		180/88/87-101	Element modułowy/otomana z pojemnikiem	11 478	12 017	12 398	12 852	13 540	14 870	22 639	25 000	1,35	63	1
	SEGM.2OT L/P N/CR		180/98/87-101	Element modułowy/otomana nie posiada pojemnika	17 509	18 596	19 387	20 343	21 766	24 284	31 012	35 770	1,65	78	1
	SEGM.H1N N/CR		100/100/87	Element modułowy narożny, brak możliwości bezpośredniego łączenia z elementami z funkcją relax	8 401	8 904	9 257	9 684	10 326	11 254	15 586	18 233	0,85	33	1
	SEGM.H2N N/CR		100/100/75	Element modułowy narożny, posiada drewnianą półkę, dostępna w kolorystyce N, brak możliwości bezpośredniego łączenia z elementami z funkcją relax	9 664	10 019	10 269	10 576	11 032	11 571	15 921	18 346	0,65	62	1
PRVKY S NOHOU CR1	FOT.BF CR1		96/98/87-101	Fotel	8 990	9 490	9 890	10 290	10 990	11 990	15 990	17 990	0,80	42	1
	FOT.RE CR1		96/98/87-101	Fotel z funkcją relaks	19 990	20 490	20 990	21 490	22 490	23 590	27 990	30 490	0,80	64	1
	SOF.2BF CR1		176/98/87-101	Sofa	13 890	14 590	14 990	15 690	16 590	18 390	25 990	29 490	1,40	73	1
	SOF.2P CR1		176/98/87-101	Sofa	15 690	16 390	16 890	17 490	18 490	19 990	27 490	30 590	1,40	68	1

SYMBOL	ROZMĚRY (š / h / v)	POPIS	CENY										OBJEM (m3)	VÁHA (kg)	MNOŽSTVÍ (ks)
			A1	A2	B1	B2	B3	B4	S1	S2					
SOF.3BF CR1		228/98/87-101 Sofa	17 590	18 490	18 990	19 890	20 990	23 290	31 990	36 490	1,90	91	1		
SOF.3R CR1		228/98/87-101 Sofa z funkcją spania, pow. spania 138x195	22 990	23 990	24 990	25 790	26 990	29 390	37 490	42 290	1,90	105	1		
SEGM.1BF L/P CR1		78/98/87-101 Element modułowy	7 118	7 463	7 713	8 002	8 448	9 339	12 769	14 414	0,65	30	1		
SEGM.1RE L/P CR1		78/98/87-101 Element modułowy z funkcją relaks, brak możliwości łączenia z elementami z funkcją spania oraz elementem narożnym	17 295	17 769	18 047	18 475	19 052	19 581	23 168	24 415	0,65	62	1		
SEGM.2BF L/P CR1		158/98/87-101 Element modułowy	11 793	12 398	12 826	13 336	14 107	15 446	22 686	25 742	1,30	61	1		
SEGM.2R L/P CR1		158/98/87-101 Element modułowy z funkcją spania, może być stosowany wyłącznie przy budowie narożników, pow. spania 138x195	16 375	17 073	17 573	18 178	19 080	20 696	26 729	29 786	1,30	64	1		
SEGM.2P L/P CR1		158/98/87-101 Element modułowy z pojemnikiem	12 993	13 606	14 042	14 563	15 372	16 988	23 680	26 662	1,30	56	1		
SEGM.3BF L/P CR1		210/98/87-101 Element modułowy	16 320	17 109	17 676	18 346	19 367	21 078	29 265	33 205	1,80	79	1		
SEGM.3R L/P CR1		210/98/87-101 Element modułowy z funkcją spania, może być stosowany wyłącznie przy budowie narożników, pow. spania 138x240	21 235	22 175	22 928	23 662	24 740	25 966	34 981	39 553	1,80	90	1		
SEGM.1OT L/P CR1		180/88/87-101 Element modułowy/ otomana z pojemnikiem	12 555	13 086	13 465	13 921	14 609	15 836	23 717	25 966	1,35	63	1		
SEGM.2OT L/P CR1		180/98/87-101 Element modułowy/otomana nie posiada pojemnika	18 233	19 320	20 111	21 068	22 490	25 008	31 737	36 496	1,65	78	1		

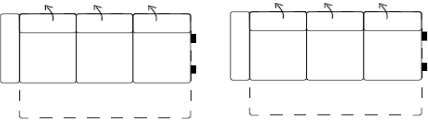
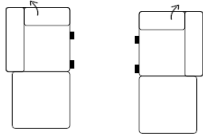
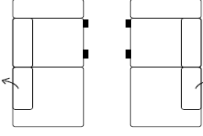
PRVKY S NIOHOU CR1

SYMBOL	ROZMĚRY (š / h / v)	POPIS	CENY										OBJEM (m3)	VÁHA (kg)	MNOŽSTVÍ (ks)
			A1	A2	B1	B2	B3	B4	S1	S2					
FOT.BF CR2		96/98/87-101 Fotel	8 590	8 990	9 490	9 890	10 490	11 690	15 790	17 790	0,80	42	1		
FOT.RE CR2		96/98/87-101 Fotel z funkcją relaks	19 590	19 990	20 590	20 990	21 990	22 990	27 590	29 990	0,80	64	1		
SOF.2BF CR2		176/98/87-101 Sofa	13 390	13 990	14 590	14 990	15 990	17 990	25 590	28 990	1,40	73	1		
SOF.2P CR2		176/98/87-101 Sofa	14 990	15 990	16 490	16 990	17 990	19 590	26 990	29 990	1,40	68	1		
SOF.3BF CR2		228/98/87-101 Sofa	16 990	17 990	18 690	19 390	20 590	22 890	31 490	35 990	1,90	91	1		
SOF.3R CR2		228/98/87-101 Sofa z funkcją spania, pow. spania 138x195	22 790	23 790	24 490	25 390	26 690	28 990	36 990	41 990	1,90	105	1		
SEGM.1BF L/P CR2		78/98/87-101 Element modułowy	6 886	7 231	7 481	7 770	8 216	9 136	12 565	14 210	0,65	30	1		
SEGM.1RE L/P CR2		78/98/87-101 Element modułowy z funkcją relaks, brak możliwości łączenia z elementami z funkcją spania oraz elementem narożnym	17 091	17 565	17 843	18 271	18 846	19 377	22 964	24 209	0,65	62	1		
SEGM.2BF L/P CR2		158/98/87-101 Element modułowy	11 561	12 166	12 592	13 104	13 875	15 241	22 482	25 539	1,30	61	1		
SEGM.2R L/P CR2		158/98/87-101 Element modułowy z funkcją spania, może być stosowany wyłącznie przy budowie narożników, pow. spania 138x195	16 171	16 867	17 369	17 973	18 875	20 492	26 523	29 582	1,30	64	1		
SEGM.2P L/P CR2		158/98/87-101 Element modułowy z pojemnikiem	12 759	13 373	13 810	14 331	15 166	16 784	23 448	26 459	1,30	56	1		
SEGM.3BF L/P CR2		210/98/87-101 Element modułowy	16 086	16 877	17 444	18 114	19 135	20 874	29 033	33 001	1,80	79	1		

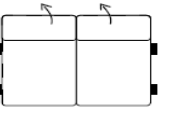
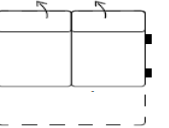
PRVKY S NOHOUCR 2

SYMBOL	ROZMĚRY (š / h / v)	POPIS	CENY								OBJEM (m3)	VÁHA (kg)	MNOŽSTVÍ (ks)	
			A1	A2	B1	B2	B3	B4	S1	S2				
SEGM.3R L/P CR2		210/98/87-101 Element modułowy z funkcją spania, może być stosowany wyłącznie przy budowie narożników, pow. spania 138x240	21 031	21 969	22 722	23 456	24 534	25 762	34 777	39 349	1,80	90	1	
SEGM.10T L/P CR2		180/88/87-101 Element modułowy/ otomana z pojemnikiem	12 091	12 620	13 001	13 465	14 145	15 427	23 253	25 557	1,35	63	1	
SEGM.20T L/P CR2		180/98/87-101 Element modułowy/otomana nie posiada pojemnika	17 926	19 014	19 805	20 761	22 183	24 701	31 430	36 189	1,65	78	1	
SEGM.H1N CR2		100/100/87 Element modułowy narożny, brak możliwości bezpośredniego łączenia z elementami z funkcją relax	8 708	9 210	9 563	9 991	10 632	11 533	15 864	18 513	0,85	33	1	
SEGM.H2N N CR2		100/100/75 Element modułowy narożny, posiada drewnianą półkę, dostępna w kolorystyce N, brak możliwości bezpośredniego łączenia z elementami z funkcją relax	9 973	10 326	10 576	10 883	11 339	11 849	16 199	18 624	0,85	33	1	
PRVKY BEZ NOHOU	SEGM.1BF BB		56/98/87-101 Element modułowy wewnętrzny	5 121	5 334	5 558	5 819	6 198	6 551	9 349	10 623	0,55	24	1
	SEGM.2BF BB		140/98/87-101 Element modułowy wewnętrzny	10 251	10 772	11 143	11 599	12 277	12 890	19 619	22 379	1,15	52	1
	SEGM.2R BB		140/98/87-101 Element modułowy wewnętrzny z funkcją spania, może być stosowany wyłącznie przy budowie narożników, pow. spania min. 138x195	14 182	14 795	15 251	15 790	16 589	18 039	23 196	25 928	1,15	66	1
	PUF.BF 65x65		65/65/47 Puf	2 710	2 940	3 080	3 290	3 580	3 860	5 430	5 930	0,20	14	1
AKU.	akumulator		4 690											
MAT.2R	materacyk zatapicerowany tkaniną włóściwą mebla, dotyczy elementów z 2R		763	1 124	1 366	1 673	2 137	2 937				NETÝKÁ SE		
MAT.3R	materacyk zatapicerowany tkaniną włóściwą mebla, dotyczy elementów z 3R		930	1 348	1 664	2 026	2 574	3 569						

ROZMĚRY (cm)	
hloubka nábytku	98
výška nábytku	87-101
výška sezení	47
hloubka sezení	55
šířka boku / výška boku	22/60

ČALOUNĚNÍ	
koordináty	ne
doplňkové prošití v kůži	ano
omezení tkanin a kůží	tkaniny se vzory
kontrastní prošití	ne

NOHY			
			
NOHA DŘEVĚNÁ N	NOHA KOVOVÁ CR	NOHA KOVOVÁ CR1	NOHA KOVOVÁ CR2

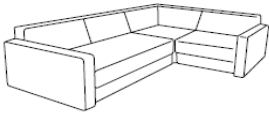
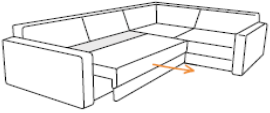
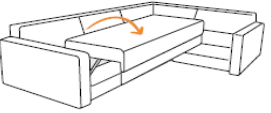
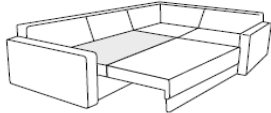





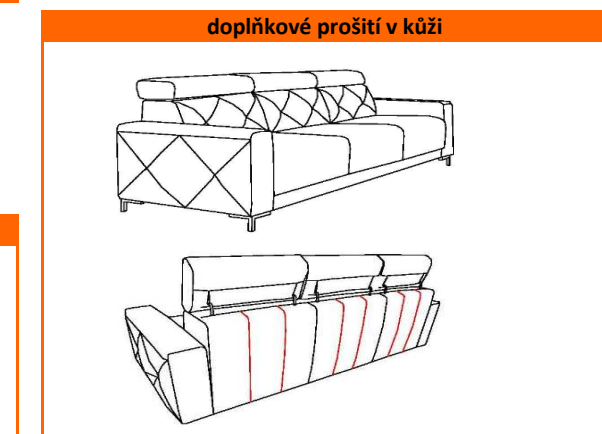

ZPŮSOB ROZKLÁDÁNÍ FUNKCE SPANÍ			
			
ROZKLÁDÁNÍ TYPU 04 (LEOPARD)			



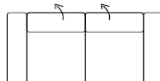
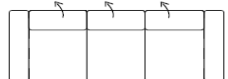
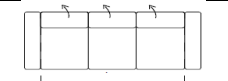

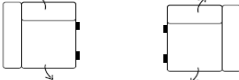
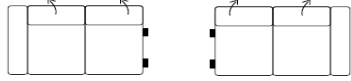

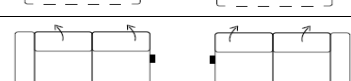

FUNKCE	
funkce spaní	leopard
úložný prostor	ano - SOF.2P, SEGM.2P, SEGM.1OT
nastavitelné prvky	nastavitelné záhlavky
ostatní	

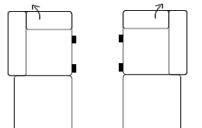
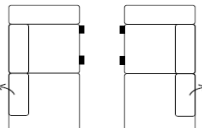
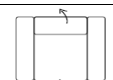
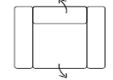
SLOŽENÍ	
opěrák	pěna polyuretanová
sedák	pěna vysoce elastická/ lištová pružina



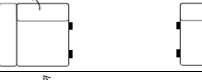

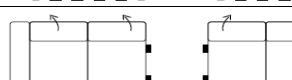

ostatní
<ol style="list-style-type: none"> Nábytek bez koordinátů V případě tkaniny: CARABU HT se mohou vyskytnout potíže při rozkládání funkce spaní V případě čalounění přírodní kůží se používá doplňkové prošití Uvedené ceny jsou cenami částečnými. Pro získání celkové prodejní ceny je potřeba sečíst jednotlivé prvky sestavy a boky, a to zapsané zleva doprava, jak jdou po sobě S ohledem na měkké prvky a způsob očalounění se mohou vyskytnout malé rozdíly v rozměrech nábytku Správný postup zápisu vybraných prvků na objednávce je jejich postupné uvedení zleva doprava

SYMBOL	ROZMĚRY (š / h / v)	POPIS	CENY								OBJEM (m3)	VÁHA (kg)	MNOŽS TVÍ (ks)	
			A1	A2	B1	B2	B3	B4	S1	S2				
FOT. BF CR1	96/98/87-101		Fotel	8 990	9 390	9 790	9 990	10 690	11 590	15 990	17 390	0,80	42	1
FOT.RE CR1	96/98/87-101		Fotel z funkcją relaks	20 690	21 290	21 790	22 190	22 990	24 290	28 590	30 990			
SOF. 2BF CR1	176/98/87-101		Sofa	13 590	14 290	14 790	15 290	16 290	17 790	25 390	27 590	1,40	73	1
SOF. 2P CR1	176/98/87-101		Sofa z pojemnikiem	14 890	15 590	15 990	16 690	17 690	19 390	26 490	28 690	1,40	68	1
SOF. 3BF CR1	228/98/87-101		Sofa	16 790	17 690	18 290	18 990	20 390	22 690	31 290	33 990	1,90	91	1
SOF. 3R CR1	228/98/87-101		Sofa z funkcją spania, pow.spania 138x195	22 590	23 590	24 390	25 190	26 490	28 790	37 290	39 990	1,90	105	1
SEGM. 1BF L/P CR1	78/98/87-101		Element modułowy	7 171	7 527	7 784	8 096	8 553	9 076	12 692	13 682	0,65	30	1
SEGM.1RE L/P CR1	78/98/87-101		Element modułowy z funkcją relaks, brak możliwości bezpośredniego łączenia z elementem narożnym oraz elementami z funkcją spania	17 565	18 013	18 362	18 728	19 295	19 873	23 490	25 148			
SEGM. 2BF L/P CR1	158/98/87-101		Element modułowy	11 849	12 454	12 875	13 408	14 195	15 120	22 345	24 406	1,3	61	1
SEGM. 2R L/P CR1	158/98/87-101		Element modułowy z funkcją spania, stosowany wyłącznie przy budowie układów narożnych 138X195	16 062	16 750	17 253	17 857	18 774	20 358	26 339	28 416	1,30	78	1
SEGM. 2P L/P CR1	158/98/87-101		Element modułowy z pojemnikiem	13 060	13 700	14 158	14 716	15 541	16 676	23 526	25 440	1,30	56	1
SEGM. 3BF L/P CR1	213/98/87-101		Element modułowy	15 706	16 547	17 144	17 857	18 939	20 752	28 545	30 898	1,80	79	1
SEGM. 3R L/P CR1	213/98/87-101		Element modułowy z funkcją spania, stosowany wyłącznie przy budowie układów narożnych 138X195	21 128	21 686	22 629	23 480	24 516	25 559	34 709	37 355	1,80	98	1

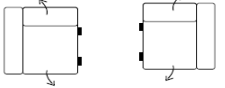
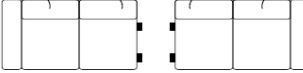
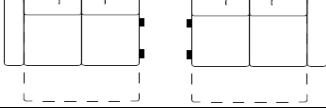
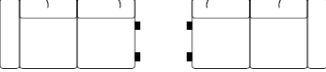
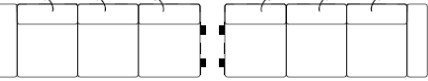
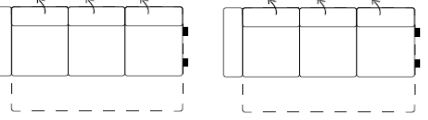
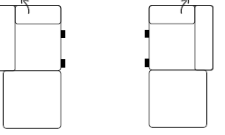
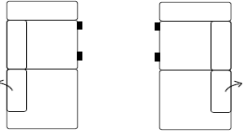
	ROZMĚRY (š / h / v)	POPIS	CENY								OBJEM (m3)	VÁHA (kg)	MNOŽS TVÍ (ks)	
			A1	A2	B1	B2	B3	B4	S1	S2				
SEGM. 1OT L/P CR1	180/88/87-101		Element modulowy/ otomana z pojemnikiem	12 317	13 060	13 571	14 213	14 973	15 641	23 828	25 907	1,35	63	1
SEGM. 2OT L/P CR1	180/88/87-101		Element modulowy/otomana	18 205	19 305	20 092	21 026	22 446	24 965	30 935	33 462	1,35	66	1
FOT. BF CR2	96/98/87-101		Fotel	8 490	8 990	9 290	9 690	10 290	10 990	15 590	16 890	0,80	42	1
FOT.RE CR2	96/98/87-101		Fotel z funkcją relaks	20 290	20 890	21 690	21 790	22 790	23 890	27 990	30 690			
SOF. 2BF CR2	176/98/87-101		Sofa	12 990	13 790	14 290	14 890	15 790	17 290	25 990	26 990	1,40	73	1
SOF. 2P CR2	176/98/87-101		Sofa z pojemnikiem	14 390	14 990	25 590	16 290	17 190	18 890	25 990	27 990	1,40	68	1
SOF. 3BF CR2	231/98/87-101		Sofa	16 290	17 190	17 890	18 690	19 890	22 190	30 790	33 490	1,90	91	1
SOF. 3R CR2	228/98/87-101		Sofa z funkcją spania, pow.spania 138x195	21 990	22 990	23 890	24 690	25 990	28 290	36 890	39 490	1,90	105	1
SEGM. 1BF L/P CR2	78/98/87-101		Element modulowy	6 942	7 298	7 555	7 867	8 324	8 809	12 464	13 454	0,65	30	1
SEGM.1RE L/P CR2	78/98/87-101		Element modulowy z funkcją relaks, brak możliwości bezpośredniego łączenia z elementem narożnym oraz elementami z funkcją spania	17 362	17 812	18 160	18 526	19 094	19 671	23 289	24 945			
SEGM. 2BF L/P CR2	158/98/87-101		Element modulowy	11 595	12 207	12 647	13 177	13 966	14 881	22 116	24 168	1,30	61	1
SEGM. 2R L/P CR2	158/98/87-101		Element modulowy z funkcją spania, stosowany wyłącznie przy budowie układów narożnych, pow.spania min. 138X195	15 806	16 511	17 006	17 611	18 508	20 110	26 118	28 206	1,30	78	1
SEGM. 2P L/P CR2	158/98/87-101		Element modulowy z pojemnikiem	12 830	13 471	13 929	14 478	15 312	16 420	23 297	25 211	1,30	56	1

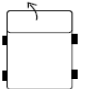
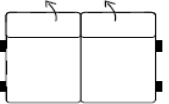
	ROZMĚRY (š / h / v)	POPIS	CENY								OBJEM (m3)	VÁHA (kg)	MNOŽS TVÍ (ks)		
			A1	A2	B1	B2	B3	B4	S1	S2					
NOHA CR2	SEGM. 3BF L/P CR1	213/98/87-101		Element modulový	15 477	16 310	16 915	17 629	18 700	20 496	28 317	30 669	1,80	79	1
	SEGM. 3R L/P CR1	213/98/87-101		Element modulový z funkcí spania, stosovaný výlučně při budování úkládů narožných, pow.spania min. 138X195	20 651	21 585	22 336	23 060	24 140	25 358	34 323	36 969	1,80	98	1
	SEGM. 1OT L/P CR2	180/88/87-101		Element modulový/otomana z pojemníkem	11 768	12 501	13 022	13 654	14 505	15 175	23 370	25 440	1,35	63	1
	SEGM. 2OT L/P CR2	180/88/87-101		Element modulový/otomana	17 418	18 508	19 287	20 239	21 659	24 168	30 862	33 381	1,35	66	1
	SEGM. H1N CR2	100/100/87		Element modulový narožný, brak možnosti bezpřímého spojení s elementami z funkcí relax	8 462	9 094	9 561	10 056	10 696	11 292	15 569	16 694	0,85	33	1
	SEGM.H2N N CR2	100/100/75		Element modulový narožný, posiada dřevinnou pólku , dostupná v kolorystyce N, brak možnosti bezpřímého spojení s elementami z funkcí relax	9 543	9 955	10 247	10 595	11 118	11 658	15 110	15 889	0,70	34	1
NOHA CR nebo N	FOT. BF CR/N	96/98/87-101		Fotel	7 890	8 290	8 690	8 990	9 690	10 590	14 990	16 290	0,80	42	1
	FOT.RE CR/N	96/98/87-101		Fotel z funkcí relax	19 690	19 990	20 990	21 190	22 190	23 290	27 590	29 990			
	SOF. 2BF CR/N	176/98/87-101		Sofa	12 490	12 990	13 590	14 290	14 990	16 890	24 390	26 590	1,40	73	1
	SOF. 2P CR/N	176/98/87-101		Sofa z pojemníkem	13 790	14 490	14 990	15 690	16 590	18 390	25 490	27 690	1,40	68	1
	SOF. 3BF CR/N	231/98/87-101		Sofa	15 690	16 590	17 290	17 990	19 390	21 790	29 990	32 990	1,90	91	1
	SOF. 3R CR/N	228/98/87-101		Sofa z funkcí spania, pow.spania 138x195	21 590	22 590	23 390	23 990	25 490	27 790	25 990	38 890	1,90	105	1
	SEGM. 1BF L/P CR/N	78/98/87-101		Element modulový	6 640	6 996	7 253	7 565	8 022	8 563	12 161	13 151	0,65	30	1

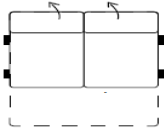
	ROZMĚRY (š / h / v)	POPIS	CENY								OBJEM (m3)	VÁHA (kg)	MNOŽS TVÍ (ks)		
			A1	A2	B1	B2	B3	B4	S1	S2					
NOHA CR nebo N	SEGM.1RE L/P CR/N	78/98/87-101		Element modulový z funkcí relax, brak možnosti bezpořadného řazení z elementem naružným oraz elementami z funkcí spania	17 060	17 509	17 857	18 223	18 792	19 368	22 987	24 643			
	SEGM. 2BF L/P CR/N	158/98/87-101		Element modulový	11 301	11 915	12 354	12 875	13 664	14 635	21 842	23 921	1,30	61	1
	SEGM. 2R L/P CR/N	158/98/87-101		Element modulový z funkcí spania, stosowany wyłącznie przy budowie układów naružnych 138X195	15 559	16 265	16 758	17 362	18 261	19 863	25 871	27 959	1,30	78	1
	SEGM. 2P L/P CR/N	158/98/87-101		Element modulový z pojemníkem	12 527	13 169	13 627	14 185	15 010	16 173	23 005	24 909	1,30	56	1
	SEGM. 3BF L/P CR/N	213/98/87-101		Element modulový	15 175	16 016	16 613	17 327	18 408	20 247	28 068	30 422	1,80	79	1
	SEGM. 3R L/P CR/N	213/98/87-101		Element modulový z funkcí spania, stosowany wyłącznie przy budowie układów naružnych 138X195	20 404	21 338	22 098	22 812	23 893	25 110	34 076	36 723	1,80	98	1
	SEGM. 1OT L/P CR/N	180/88/87-101		Element modulový/ otomana z pojemníkem	11 219	11 960	12 482	13 106	13 911	14 579	22 776	24 846	1,35	63	1
	SEGM. 2OT L/P CR/N	180/88/87-101		Element modulový/otomana	17 042	18 132	18 911	19 863	21 283	23 792	30 486	33 005	1,35	66	1
	SEGM. H1N CR/N	100/100/87		Element modulový naružný, brak možnosti bezpořadného řazení z elementami z funkcí relax	8 187	8 827	9 286	9 762	10 394	10 990	15 267	16 448	0,85	33	1
SEGM.H2N N CR/N	100/100/75		Element modulový naružný, posiada drewnianą półkę , dostępna w kolorystyce N, brak možnosti bezpořadného řazení z elementami z funkcí relax	9 268	9 680	9 973	10 330	10 851	11 364	14 835	15 641	0,70	34	1	
PRVKY BEZ NOHOU	SEGM.1BF BB	56/98/87-101		Element modulový wewnuřný	5 640	5 907	6 099	6 328	6 666	6 978	9 571	10 229	0,60	24	1
	SEGM.2BF BB	140/98/87-101		Element modulový wewnuřný	10 330	10 851	11 227	11 686	12 372	12 977	19 726	21 448	1,15	56	1

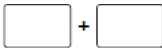
	ROZMĚRY (š / h / v)	POPIS	CENY								OBJEM (m3)	VÁHA (kg)	MNOŽS TVÍ (ks)		
			A1	A2	B1	B2	B3	B4	S1	S2					
PRVKY DOPĹNKOVÉ	SEGM. 2R BB	140/98/87-101		Element modulowy wewnętrzny z funkcją spania, stosowany wyłącznie przy budowie układów narożnych 138X195	14 112	14 726	15 175	15 714	16 511	17 949	23 078	24 808	1,15	66	1
	PUF. BF 60x60	65/65/47		Puf	2 690	2 920	3 070	3 270	3 560	4 090	5 530	5 990	0,20	13,5	1
	H2	45x32		Komplet poduszek , rekomendowany do SEGM.H2A	660	810	920	1 050	1 240	1 420					1
	AKU.	akumulator													
	LIFE.MAT.2R	materacyk zatapicerowany tkaniną właściwą mebla, dotyczy elementów z 2R			751	1 108	1 346	1 648	2 106	2 895			NETÝKÁ SE		
	LIFE.MAT.3R	materacyk zatapicerowany tkaniną właściwą mebla, dotyczy elementów z 3R			916	1 328	1 640	1 996	2 537	3 517					

ROZMĚRY (cm)	
hloubka nábytku	100/105
výška nábytku	80/100
výška sezení	47
hloubka sezení	58
šířka boku / výška boku	26/62

FUNKCE	
funkce spaní	delfin: SOF.3W, SEGM.3W, SEGM.2W
úložný prostor	SEGM.1HT a SEGM.1OT
nastavitelné prvky	nastavitelné záhlavky
ostatní	funkce relax



ČALOUNĚNÍ	
KOORDINÁTY	ne
DOPLŇKOVÉ PROŠITÍ V KŮŽI	ano - záda korpusu
omezení tkanin a kůží	tkaniny se vzory
kontrastní prošití	ano - u kůží S1, S2 a u tkaniny GENUA

SLOŽENÍ	
opěrák	lištová pružina, pěna vysoce elastická
sedák	čalounický pás, pěna vysoce elastická

NOHY



NOHA KOVOVÁ CR - S POVRCHEM V ČERNÉM CHROMU

ZPŮSOB ROZKLÁDÁNÍ FUNKCE SPANÍ

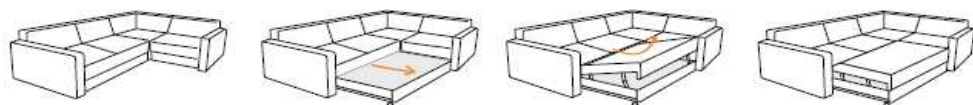

ROZKLÁDÁNÍ TYPU 01 (DELFIN)



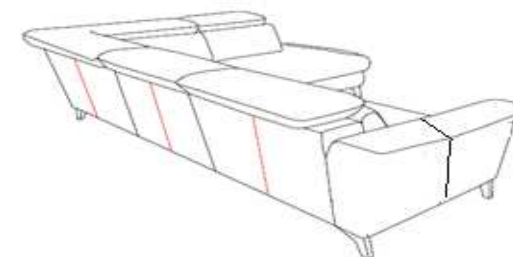

DOPLŇKOVÉ PROŠITÍ V KŮŽI





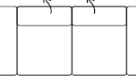
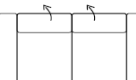
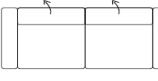
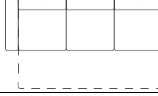
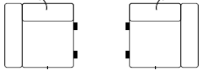
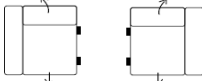
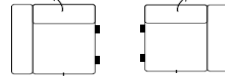
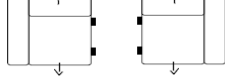
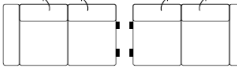
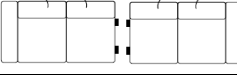

ostatní

1. V případě tkaniny: CARABU HT se mohou vyskytnout potíže při rozkládání funkce spaní a u nastavování záhlavků.
2. U kůží je použito doplňkové prošití.
3. Uvedené ceny jsou cenami částečnými. Pro získání celkové prodejní ceny je potřeba sečíst jednotlivé prvky sestavy a boky, a to zapsané zleva doprava, jak jdou po sobě.
4. S ohledem na měkké prvky a způsob očalounění se mohou vyskytnout malé rozdíly v rozměrech nábytku.

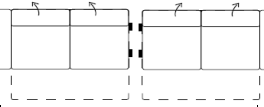
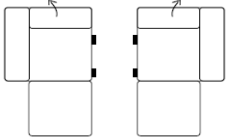
MOCCA

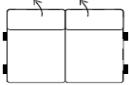
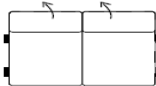
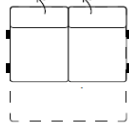
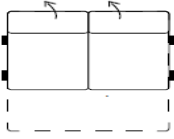
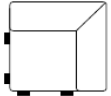
SYMBOL	ROZMĚRY (š / h / v)	POPIS	CENA								OBJEM (m3)	VÁHA (kg)	MNOŽSTVÍ (ks)	
			A1	A2	B1	B2	B3	B4	S1	S2				
FOT.BF	112/100-105/80-100		Fotel	10 990	11 790	12 190	12 890	13 690	14 490	18 990	20 790	1,03	42	1
FOT.RE	112/100-105/80-100		Fotel z funkcją relax	18 590	19 325	19 856	20 514	21 487	22 346	27 415	28 809	1,03	42	1
SOF.2BF	179/100-105/80-100		Sofa	16 690	17 690	18 390	18 990	20 390	21 490	27 990	30 690	1,64	72	1
SOF.2P	179/100-105/80-100		Sofa z pojemnikiem	16 990	17 990	18 790	19 590	20 890	21 990	28 890	30 990	1,64	72	1
SOF.3BF	204/100-105/80-100		Sofa	17 990	18 990	19 890	20 790	21 990	23 390	30 990	34 290	1,87	75	1
SOF.3W	242/100-108/80/100		Sofa z funkcją spania, nie posiada pojemnika, pow. spania 190x120	25 790	26 990	27 990	29 390	30 990	32 890	42 790	46 990	1,87	91	1
SEGM.1BF	90/100-105/80-100		Moduł bezfunkcyjny	8 789	9 308	9 674	10 129	10 798	11 393	15 707	17 081	0,81	40	1
SEGM.1RE L/P	90/100-105/80-100		Element modułowy z funkcją relax, brak możliwości łączenia z elementami z funkcją spania oraz elementem narożnym	16 380	16 975	17 379	17 885	18 631	19 301	23 863	25 429	0,81	60	1
SEGM.1,5BF L/P	104/100-105/80-100		Moduł bezfunkcyjny	9 787	10 369	10 773	11 266	12 000	12 643	17 054	18 850	0,94	45	1
SEGM.1,5RE L/P	104/100-105/80-100		Element modułowy z funkcją relax, brak możliwości łączenia z elementami z funkcją spania oraz elementem narożnym	17 834	18 478	18 934	19 490	20 312	21 056	25 923	27 883	0,94	65	1
SEGM.2BF L/P	153/100-105/80-100		Moduł bezfunkcyjny	13 998	14 768	15 325	15 982	16 981	17 865	22 845	24 640	1,4	69	1
SEGM.2P L/P	153/100-105/80-100		Moduł z pojemnikiem	15 879	16 827	17 497	18 306	19 533	20 607	27 407	29 858	1,4	65	1
SEGM.3BF L/P	178/100-105/80-100		Moduł bezfunkcyjny	15 476	16 361	16 993	17 764	18 901	19 926	26 245	28 950	1,63	71	1

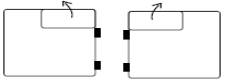
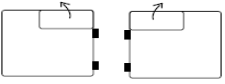
SYMBOL	ROZMĚRY (š / h / v)	POPIS	CENA										OBJEM (m3)	VÁHA (kg)	MNOŽSTVÍ (ks)
			A1	A2	B1	B2	B3	B4	S1	S2					
SEGM.3W L/P	178/100-105/80-100	 Modul z funkcją spania, dedykowany układom narożnym, pow. spania min. 120x236	18 218	19 052	19 659	20 380	21 466	22 427	30 364	33 195	1,63	85	1		
SEGM.1OT L/P	109/185-194/80-100	 Otomana z pojemnikiem	14 707	15 428	15 934	16 552	17 475	18 296	23 732	25 981	1,78	68	1		
SEGM.1BF BB	64/100-105/80-100	 Moduł bezfunkcyjny, bez boków	6 143	6 483	6 737	7 027	7 483	7 874	10 490	11 553	0,59	26	1		
SEGM.1,5BF BB	78/100-105/80-100	 Moduł z funkcją relax, bez boków	7 141	7 546	7 824	8 164	8 683	9 139	11 818	12 652	0,71	32	1		
SEGM.2BF BB	128/100-105/80-100	 Moduł bezfunkcyjny, bez boków	10 782	11 375	11 804	12 310	13 069	13 751	20 058	22 308	1,17	59	1		
SEGM.3BF BB	154/100-105/80-100	 Moduł bezfunkcyjny, bez boków	12 247	12 942	13 447	14 054	14 964	15 773	21 056	23 243	1,41	62	1		
SEGM.2W BB	128/100-105/80-100	 Element modułowy z funkcją spania, dedykowany układom narożnym, pow. spania min. 120x236	14 699	15 319	15 761	16 292	17 076	17 784	23 813	25 999	1,21	70	1		
SEGM.3W BB	154/100-105/80-100	 Element modułowy z funkcją spania, dedykowany układom narożnym, pow. spania min. 120x236	16 128	16 811	17 316	17 910	18 795	19 591	25 114	27 301	1,41	72	1		
SEGM.H	102/102/80	 Element modułowy narożny, brak możliwości łączenia z elementami z funkcją relax	8 373	8 915	9 308	9 775	10 470	11 090	14 933	16 474	1	38	1		

SYMBOL	ROZMĚRY (š / h / v)	POPIS	CENA								OBJEM (m3)	VÁHA (kg)	MNOŽSTVÍ (ks)	
			A1	A2	B1	B2	B3	B4	S1	S2				
SEGM.1HT L/P	100-105/102/80-100		Moduł	9 901	10 319	10 621	10 989	11 544	12 025	15 559	16 948	0,93	37	1
SEGM.1HT BF L/P	100-105/102/80-100		Moduł	9 467	9 910	10 225	10 618	11 186	11 703	15 231	16 620	0,93	36	1
PUF.BF	60/60/47		Pufa, nie posiada pojemnika	3 930	4 120	4 270	4 430	4 690	4 910	6 390	6 990	0,17	15	1
MAT.3	materacyk tapicerowany tkaniną właściwą mebla			902	1 170	1 366	1 598	1 951	2 574			NETÝKÁ SE		
AKU.	akumulátor			5 240								NETÝKÁ SE		

ROZMĚRY (cm)	
hloubka nábytku	97 cm
výška nábytku	87 cm
výška sezení	45 cm
hloubka sezení	54 cm
šířka boku / výška boku	15/67cm

ČALOUNĚNÍ	
koordináty	ne
doplňkové prošití v kůži	netýká se
omezení tkanin a kůží	CARABU HP, GENUA, RAJAN, VIENNA, KŮŽE
kontrastní prošití	netýká se

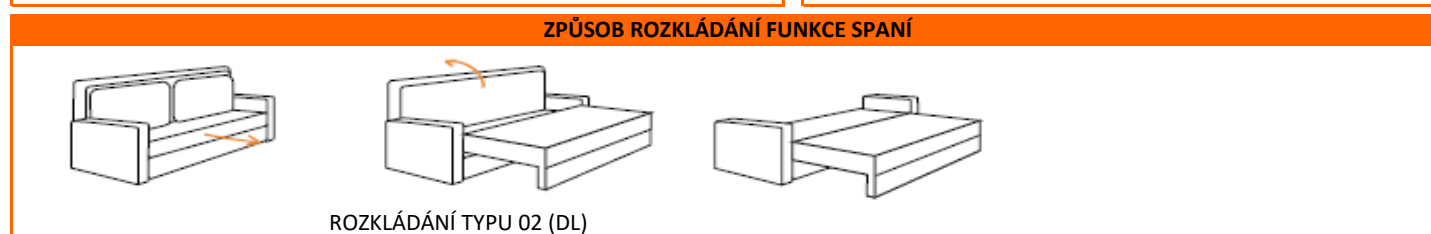
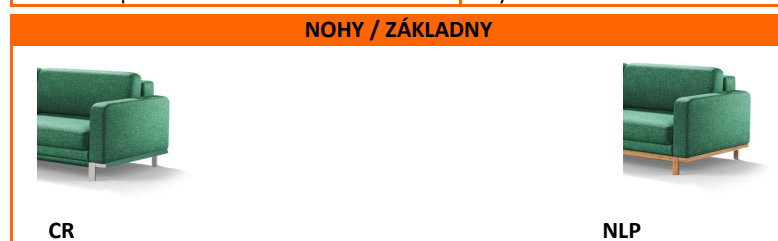

ostatní	
<ol style="list-style-type: none"> Nábytek bez koordinátů Možnost výběru nohou: CR - kovová, chromovaná, NLP - nohy a lišty dřevěné pod bokem a korpusem nábytku, dostupné v 10 barvách Možnost výběru zakončení korpusových lišt (očalounění tkaninou nebo dřevěné) Různé rozměry hloubky nábytku jsou dány rozdílnými konstrukcemi sestav s funkcí spaní a bez funkce 	

FUNKCE	
funkce spaní	DL
úložný prostor	ano, s funkcí spaní
nastavitelné prvky	ne
ostatní	

SLOŽENÍ	
sedák	pěna vysoce elastická, lištová pružina
opěrák	volný opěrný polštářek se směsí silikonu a pěny

koordináty	
ne	



doplňkové prošití v kůži	
netýká se	

MODO

SYMBOL	ROZMĚRY (š / h / v)		POPIS	CENY						OBJEM (m3)	VÁHA (kg)	MNOŽSTVÍ (ks)
				A1	A2	B1	B2	B3	B4			
FOT.BF		95/87/87	křeslo	8 460	8 990	9 490	9 990	10 836	11 543	0,7	38	1
SOF.2BF		160/87/87	pohovka	13 660	14 640	15 250	15 911	16 895	17 769	1,2	45	1
SOF.2,5BF		206/87/87	pohovka	15 550	16 490	17 190	18 094	19 367	20 492	1,5	49	1
SOF.3R		230/87/87	pohovka z funkcí spania, pow. spania 142X200	19 330	20 590	21 470	22 639	24 302	25 762	2,1	94	2
NAR.2BF/1OTS P/L		227x147/87/87	Narožnik	21 330	22 630	23 570	24 832	26 755	28 476	2,1	102	3
NAR.2,5BF/1OTS P/L		273x147/87/87	Narožnik	23 490	24 990	25 990	27 453	29 674	31 636	2,1	110	2
NAR.2R/1OTM P/L		231x155/97/87	Narožnik z funkcí spania, pow. spania 142X200	24 790	25 990	26 990	28 169	29 850	31 347	2,2	105	3
NAR.2BF/2OTS P/L		234x182/87/87	Narožnik	26 590	28 280	29 490	30 956	33 141	35 084	2,3	115	3
NAR.2R/2OTM P/L		246x192/97/87	Narožnik z funkcí spania, pow. spania 142X205	28 490	29 990	30 990	32 584	35 176	37 471	2,3	110	3
PUF.		65/65/45	Puf	4 090	4 290	4 450	4 628	4 879	5 102	0,3	15	1
STS. 83		83/55/28	Stolík okolnicnościowy z fornirowanym blatem	3 990	4 090	4 180	4 275	4 414	4 526	0,2	17	1

MULA

ROZMĚRY (cm)	
hloubka nábytku	60
výška nábytku	82
výška sezení	44
hloubka sezení	54
šířka boku / výška boku	ne

ČALOUNĚNÍ	
KOORDINÁTY	ano
DOPLŇKOVÉ PROŠITÍ V KŮŽI	ano
omezení tkanin a kůží	není možné spojení kůže s tkaninou MELA
kontrastní prošíání	ne

NOHY	
	
NOHA DŘEVĚNÁ N	

FUNKCE	
funkce spaní	netýká se
úložný prostor	netýká se
nastavitelné prvky	otočný podstavec FOT. RF
ostatní	ne

SLOŽENÍ	
sedák	formovaná překližka, pěna polyuretanová
opěrák	překližka, čalounická pás, pěna vysoce elastická





KOORDINÁTY	
	
P- ZÁKLADNA K- KOORDINÁT	



ZPŮSOB ROZKLÁDÁNÍ FUNKCE SPANÍ	
NETÝKÁ SE	

ostatní	
<p>1. Nábytek s koordináty.</p> <p>2. U kůží je použito doplňkové prošíání.</p> <p>4. S ohledem na měkké prvky a způsob očalounění se mohou vyskytnout malé rozdíly v rozměrech nábytku.</p>	

MULA

	ROZMĚRY (š / h / v)		POPIS	CENY								OBJEM (m3)	VÁHA (kg)	MNOŽSTVÍ
				A1	A2	B1	B2	B3	B4	S1	S2			
FOT.BF N	60/76/82		Fotel	7 290	7 790	7 990	8 390	8 890	9 290	11 590	12 890	0,3	18	1
FOT.BF RF	60/76/82		Fotel z funkcí obrotová	8 690	8 990	9 290	9 590	9 990	10 590	13 390	14 790	0,40	26	1
PUF.BF N	56/56/44		Pufa	3 990	4 190	4 390	4 590	4 890	4 990	6 990	7 790	0,08	9	1
PUF.BF	56/56/44		Pufa	5 390	5 590	5 790	5 990	6 290	6 490	8 190	8 990	0,16	11	1

ROZMĚRY (cm)	
hloubka nábytku	87, 90, 97*
výška nábytku	88
výška sezení	45
hloubka sezení	56
šířka boku / výška boku	15/60

ČALOUNĚNÍ	
koordináty	ne
omezení tkanin a kůží	kůže, v případě tkanin potahových: GENUA, RAJAN, VIENNA mohou být použity jako koordinát

FUNKCE	
funkce spaní	3DL - u prvků 2R a 3R
úložný prostor	ano - v elementech 2R a 3R

SLOŽENÍ	
opěrák	volný opěrný polštářek vyplněný směsí silikonu a pěny
sedák	pěna vysoce elastická/pěna polyuretanová/lištová pružina



NOHY



NOHA DŘEVĚNÁ NB (oválná)



NOHA DŘEVĚNÁ NA (čtvercová)

koordináty



koordináty

ZPŮSOB ROZKLÁDÁNÍ FUNKCE SPANÍ

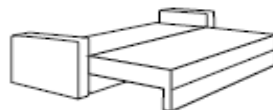
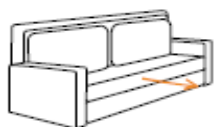

ROZKLÁDÁNÍ TYPU 02

doplňkové prošití v kůži





netýká se

ostatní

1. Nábytek s koordináty
2. V případě tkanin CARABU HT se mohou vyskytnout potíže při rozkládání funkce spaní
3. Prošití na polštářcích je zvláště malými čalounickými knoflíky
4. Výběr typu nohy nemá vliv na cenu
5. * Různé rozměry hloubky jsou dány základem konstrukce a použitím funkce spaní
6. S ohledem na měkké prvky a způsob očalounění se mohou vyskytnout malé rozdíly v rozměrech nábytku

OLAND

	ROZMĚRY v cm (š / h / v)		POPIS	CENY							OBJEM (m3)	VÁHA (kg)	MNOŽSTVÍ (ks)
				A1	A2	B1	B2	B3	B4	S1			
PUF.BF		57/57/45	pufa	2 990	3 120	3 220	3 345	3 523	3 680		0,10	10	1
FOT.BF		87/87/88	křeslo	8 270	8 950	9 440	9 990	10 911	11 692		0,60	31	1
SOF.2BF		162/90/88	pohovka 2-osobowa	11 770	12 560	12 990	13 810	14 972	15 990		1,10	49	1
SOF.2,5BF		202/90/88	pohovka 2-osobowa	13 650	14 750	15 390	16 199	17 388	18 447		1,30	57	1
SOF.3R		232/97/88	pohovka 3-osobowa z funkcją spania, pow. spania: 142 x 197, obsahuje pojemnik	17 590	18 890	19 740	20 799	22 369	23 763		2,10	84	1
NAR.2BF/1OT S		228x160/90/88	rohovka	21 490	22 990	23 990	25 260	26 868	28 309		1,90	83	2
NAR.1OT S/2BF		160x228/90/88											
NAR.2,5BF/1OT S		268x160/90/88	rohovka	22 590	24 260	25 470	26 943	28 990	30 790		2,20	89	2
NAR.1OT S/2,5BF		160x268/90/88											
NAR.2R/1OT M		228x160/97/88	narožník z funkce spaní, pow. spania: 142 x 197	25 590	26 990	27 990	28 990	30 855	32 416		2,40	105	2

	ROZMĚRY v cm (š / h / v)		POPIS	CENY							OBJEM (m3)	VÁHA (kg)	MNOŽSTVÍ (ks)
				A1	A2	B1	B2	B3	B4	S1			
NAR.1OT M/2 R		160x228/97/88	narožník z funkcją spania, pow. spania: 142 x 197	25 590	26 990	27 990	28 990	30 855	32 416		2,40	105	2
NAR.2R/2OT M		245x196/97/88	narožník z funkcją spania, pow. spania 142 x 205	27 990	29 690	30 870	32 295	34 470	36 877		2,90	112	2
NAR.2OT M/2R		196x245/97/88											
NAR.3R/2OT M		315x196/97/88	narožník z funkcją spania, pow. spania: 142 x 272	31 690	33 590	34 950	36 571	38 990	40 990		3,50	135	2
NAR.2OT M/3R		196x315/97/88											

ROZMĚRY (cm)	
hloubka nábytku	92
výška nábytku	88-98
výška sezení	40
hloubka sezení	55
šířka boku / výška boku	30/58

ČALOUNĚNÍ	
koordináty	ne
doplňkové prošíání v kůži	ano
omezení tkanin a kůží	tkaniny se vzory
kontrastní prošíání	ne







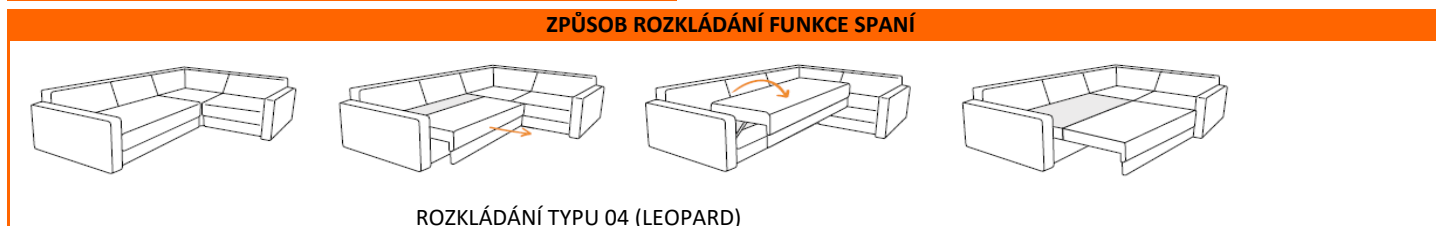
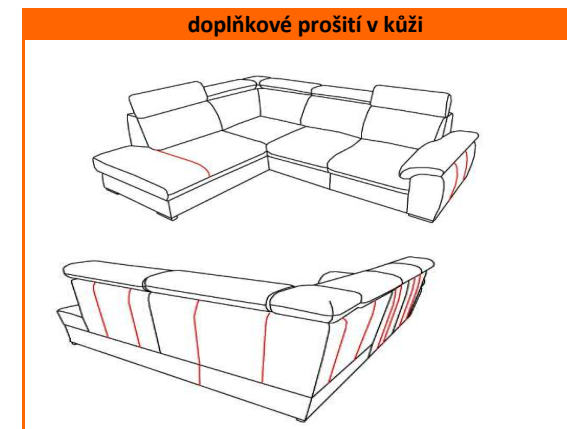





FUNKCE	
funkce spaní	leopard
úložný prostor	ano - 1P, 2P
nastavitelné prvky	nastavitelné záhlavky
ostatní	ne

SLOŽENÍ	
sedák	pěna vysoce elastická/ lištová pružina
sedák	volné opěrné polštářky/ vyprofilovaná pěna polyuretanová



ostatní
<ol style="list-style-type: none"> 1. Nábytek bez koordinátů 2. U kůží je použito doplňkové prošíání 3. V případě tkanin CARABU HT se mohou vyskytnout potíže při rozkládání funkce spaní 4. S ohledem na měkké prvky a způsob očalounění se mohou vyskytnout malé rozdíly v rozměrech nábytku

PRESTO

	ROZMĚRY (š / h / v)	POPIS	CENY										OBJEM (m3)	VÁHA (kg)	MNOŽS TVÍ
			A1	A2	B1	B2	B3	B4	S1	S2					
NOHA PLASTOVÁ V POKRYTÍ CHROMOVÝM CR	NAR.2R/1P - CR	260x165/99/88-98		obsahuje funkci spaní a úložný prostor, pow.spania 140x198	29 790	30 990	31 890	32 990	34 711	36 272	50 464	56 291	3,10	133	2
	NAR.1P/2R - CR	165x260/99/88-98		obsahuje funkci spaní a úložný prostor, pow.spania 140x198											
	NAR.2R/2P - CR	260x198/99/88-98		obsahuje funkci spaní a úložný prostor, pow.spania 140x198	32 790	34 290	35 390	36 690	38 651	40 473	56 990	63 865	3,40	151	2
	NAR.2P/2R - CR	198x260/99/88-98		obsahuje funkci spaní a úložný prostor, pow.spania 140x198											
	FOT.BF-CR	121/92/88-98		křeslo	8 630	9 270	9 720	10 279	10 990	12 565	15 947	17 983	0,85	40	1
NOHA DŘEVĚNÁ N	NAR.2R/1P - N	260x165/99/88-98		obsahuje funkci spaní a úložný prostor, pow.spania 140x198	29 590	30 890	31 790	32 990	34 609	36 171	50 361	56 179	3,10	133	2
	NAR.1P/2R - N	165x260/99/88-98		obsahuje funkci spaní a úložný prostor, pow.spania 140x198											
	NAR.2R/2P - N	260x198/99/88-98		obsahuje funkci spaní a úložný prostor, pow.spania 140x198	32 690	33 990	35 280	36 589	38 540	40 362	56 736	63 753	3,40	151	2
	NAR.2P/2R - N	198x260/99/88-98		obsahuje funkci spaní a úložný prostor, pow.spania 140x198	32 690	33 990	35 280	36 589	38 540	40 362	56 736	63 753			
FOT.BF- N	121/92/88-98		křeslo	8 630	9 270	9 720	10 270	10 990	12 565	15 872	17 900	0,85	40	1	
PRESTO.MAT.2R			tapicerowany materacyk	763	1 106	1 358	1 664	2 110	2 909				netýká se		

ROZMĚRY (cm)	
hloubka nábytku	97
výška nábytku	101
výška sezení	47
hloubka sezení	58
šířka boku / výška boku	14/65

FUNKCE	
funkce spaní	ne
úložný prostor	ne
nastavitelné prvky	ne
ostatní	



ČALOUNĚNÍ	
koordináty	ano
doplňkové prošití v kůži	ne
omezení tkanin a kůží	GENUA, MELA, RAJAN, VIENNA, KŮŽE
kontrastní prošití	ne

SLOŽENÍ	
sedák	lištová pružina, pěna vysoce elastická
opěrák	elastický pás, pěna polyuretanová





NOHY	
	
NOHY DŘEVĚNÉ N	NOHY HLINÍKOVÉ AL1 a PRÁŠKOVANÉ V BARVĚ ČERNÉ AL2

koordináty

ZPŮSOB ROZKLÁDÁNÍ FUNKCE SPANÍ
netýká se

ostatní
1. Nábytek s koordináty 2. S ohledem na měkké prvky a způsob očalounění se mohou vyskytnout malé rozdíly v rozměrech nábytku

SIBU

SYMBOL	ROZMĚRY (š / h / v)		POPIS	CENY						OBJEM (m3)	VÁHA (kg)	MNOŽSTVÍ (ks)
				A1	A2	B1	B2	B3	B4			
FOT.BF AL.		85/97/101	křeslo posadwiony na aluminiowych nogach, do wyboru AL1 NEBO AL2	9 250	9 720	9 990	10 437	10 990	11 617	0,9	36	1
FOT.BF N		85/97/101	křeslo posadwiony na drewnianych bogach , dostępnych v 10 barvách	8 540	8 990	9 330	9 721	10 316	10 873	0,9	36	1
PUF.BF AL.		59/59/46	Puf posadwiony na aluminiowych nogach, do wyboru AL1 NEBO AL2	3 960	4 190	4 350	4 535	4 814	5 064	0,2	13	1
PUF.BF N		59/59/46	Puf posadwiony na drewnianych bogach , dostępnych v 10 barvách	3 230	3 440	3 590	3 791	4 071	4 322	0,2	13	1

ROZMĚRY (cm)	
hloubka nábytku	102
výška nábytku	92
výška sezení	43
hloubka sezení	55
šířka boku / výška boku	BOK A-22/62 BOK B- 13/62

ČALOUNĚNÍ	
koordináty	ano
doplňkové prošití v kůži	ano
omezení tkanin a kůží	tkaniny se vzory
kontrastní prošití	ne





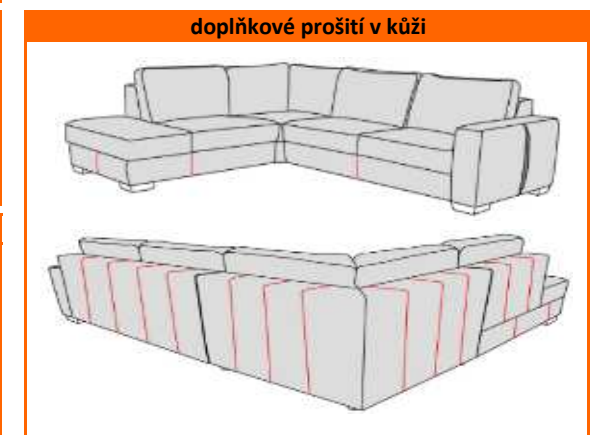
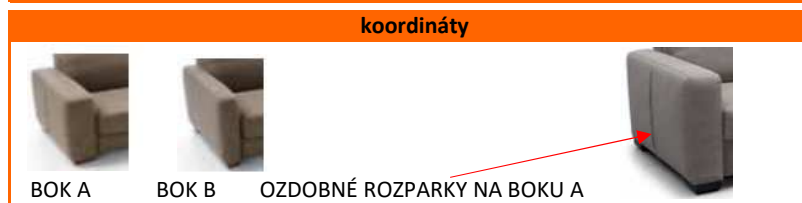

FUNKCE	
funkce spaní	rošt italský
úložný prostor	ano - 1HT, 10T
nastavitelné prvky	ne
ostatní	ne

SLOŽENÍ	
opěrák	směs silikonu a pěny
sedák	pěna polyuretanová/ lištová pružina



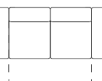
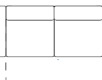
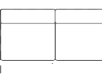
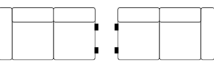

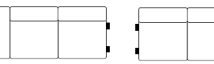
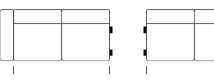
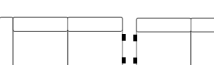
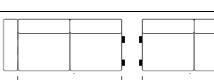

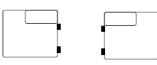
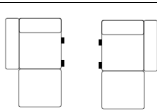





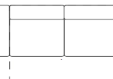
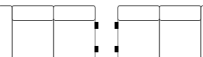
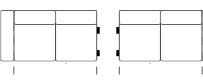

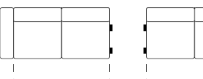

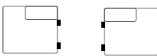
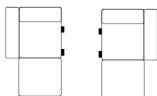

- | ostatní |
|--|
| <ol style="list-style-type: none"> Nábytek s koordinátou. Koordinátou je ozdobný rozparek na boku nábytku (BOK A), vyrobený z potahové tkaniny GENUA. U kůží je použito doplňkové prošití. V případě tkanin CARABU HP se mohou vyskytnout potíže při rozkládání funkce spaní. S ohledem na měkké prvky a způsob očalounění se mohou vyskytnout malé rozdíly v rozměrech nábytku. |

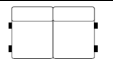
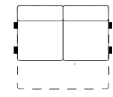
SPACE

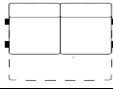
SYMBOL	ROZMĚRY (š / h / v)	POPIS	CENY										OBJEM (m ³)	VÁHA (kg)	MNOŽSTVÍ (ks)
			A1	A2	B1	B2	B3	B4	S1	S2					
FOT.BF	BOK A 94/92/92 BOK B 85/92/92		Fotel	8 490	8 990	9 290	9 690	10 290	10 790	15 690	17 490	0,85	47	1	
SOF.2,5S	BOK A 190/102/92 BOK B 173/102/92		Sofa z funkcją spania, nie posiada pojemnika, pow. spania 120x196, możliwość wyboru materaca: VP, HR lub VISCO	21 990	22 990	23 990	24 790	25 990	26 990	32 890	34 990	1,9	122	2	
SOF.3S	BOK A 210/102/92 BOK B 193/102/92		Sofa z funkcją spania, nie posiada pojemnika, pow. spania 140x196, możliwość wyboru materaca: VP, HR lub VISCO	23 490	24 590	25 290	26 190	27 590	28 790	34 990	37 790	1,90	134	2	
SOF.3,5S	BOK A 230/102/92 BOK B 213/102/92		Sofa z funkcją spania, nie posiada pojemnika, pow. spania 160x196, możliwość wyboru materaca: VP, HR lub VISCO	25 690	26 790	27 690	28 590	29 990	31 290	37 790	39 990	2,10	144	2	
SEGM.2BF L/P	BOK A 147/102/92 BOK B 138/102/92		Element modułowy	12 045	12 703	13 170	13 726	14 573	15 332	23 989	25 948	1,70	43	1	
SEGM.2,5S L/P	BOK A 170/102/92 BOK B 163/102/92		Element modułowy z funkcją spania, pow. spania 120x196, możliwość wyboru materaca: VP, HR lub VISCO	19 337	20 121	20 678	21 348	22 359	23 243	33 001	34 959	1,80	119	2	
SEGM.3BF L	BOK A 190/102/92 BOK B 181/102/92		Element modułowy	13 638	14 409	14 952	15 609	16 608	17 480	26 858	29 020	2,00	53	1	
SEGM.3S L/P	BOK A 190/102/92 BOK B 181/102/92		Element modułowy z funkcją spania, pow. spania 140x196, możliwość wyboru materaca: VP, HR lub VISCO	20 247	21 119	21 737	22 483	23 596	24 595	33 229	36 978	1,90	130	2	
SEGM.3,5BF L/P	BOK A 210/102/92 BOK B 201/102/92		Element modułowy	14 661	15 483	16 076	16 784	17 834	18 782	29 184	31 496	2,00	63	1	
SEGM.3,5S L/P	BOK A 210/102/92 BOK B 201/102/92		Element modułowy z funkcją spania, pow. spania 160x196, możliwość wyboru materaca: VP, HR lub VISCO	23 370	24 318	25 000	25 822	27 047	28 148	38 726	41 026	2,00	140	2	
SEGM.H	102/102/92		Element modułowy narożny	7 131	7 494	7 768	8 078	8 627	9 626	11 624	13 036	0,96	37	1	
SEGM.1HT L/P	136/102/92		Element modułowy z pojemnikiem	10 306	10 717	10 994	11 350	11 800	12 849	17 286	18 642	1,3	48	1	
SEGM.1OT L/P	BOK A 105/102/92 BOK B 96/102/92		Element modułowy/otomana z pojemnikiem	13 729	14 447	14 971	15 591	16 522	17 354	20 446	22 119	1,65	85	1	

NOHA KOVOVÁ CHROMOVANÁ CR

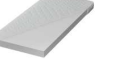
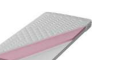
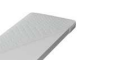
SYMBOL	ROZMĚRY (š / h / v)	POPIS	CENY										OBJEM (m ³)	VÁHA (kg)	MNOŽSTVÍ (ks)
			A1	A2	B1	B2	B3	B4	S1	S2					
FOT.BF	BOK A 94/92/92 BOK B 85/92/92		Fotel	7 890	8 490	8 890	9 290	9 990	10 690	15 390	16 790	0,85	47	1	
SOF.2,5S	BOK A 190/102/92 BOK B 173/102/92		Sofa z funkcí spania, nie posiada pojemnika, pow. spania 120x196, możliwość wyboru materaca: VP, HR lub VISCO	21 990	22 990	23 990	24 790	25 990	27 290	31 990	33 990	1,9	122	2	
SOF.3S	BOK A 210/102/92 BOK B 193/102/92		Sofa z funkcí spania, nie posiada pojemnika, pow. spania 140x196, możliwość wyboru materaca: VP, HR lub VISCO	23 490	24 590	25 290	25 990	27 590	28 790	34 990	37 790	1,90	134	2	
SOF.3,5S	BOK A 230/102/92 BOK B 213/102/92		Sofa z funkcí spania, nie posiada pojemnika, pow. spania 160x196, możliwość wyboru materaca: VP, HR lub VISCO	25 290	26 490	27 290	28 290	29 790	30 990	36 790	38 990	2,10	144	2	
SEGM.2BF L/P	BOK A 147/102/92 BOK B 138/102/92		Element modułowy	11 501	12 159	12 627	13 195	14 042	14 788	23 420	25 379	1,70	43	1	
SEGM.2,5S L/P	BOK A 170/102/92 BOK B 163/102/92		Element modułowy z funkcí spania, pow. spania 120x196, możliwość wyboru materaca: VP, HR lub VISCO	19 476	20 285	20 867	21 562	22 599	23 521	32 395	34 353	1,80	119	2	
SEGM.3BF L	BOK A 190/102/92 BOK B 181/102/92		Element modułowy	13 119	13 890	14 434	15 092	16 076	16 962	26 303	28 463	2,00	53	1	
SEGM.3S L/P	BOK A 190/102/92 BOK B 181/102/92		Element modułowy z funkcí spania, pow. spania 140x196, możliwość wyboru materaca: VP, HR lub VISCO	19 994	20 875	21 499	22 253	23 382	24 390	34 182	36 794	1,90	130	2	
SEGM.3,5BF L/P	BOK A 210/102/92 BOK B 201/102/92		Element modułowy	14 119	14 952	15 534	16 240	17 303	18 238	28 476	30 788	2,00	63	1	
SEGM.3,5S L/P	BOK A 210/102/92 BOK B 201/102/92		Element modułowy z funkcí spania, pow. spania 160x196, możliwość wyboru materaca: VP, HR lub VISCO	23 408	24 393	25 089	25 935	27 186	28 312	38 170	40 471	2,00	140	2	
SEGM.H	102/102/92		Element modułowy narożny	7 131	7 494	7 768	8 078	8 627	9 626	11 624	13 036	0,96	37	1	
SEGM.1HT L/P	136/102/92		Element modułowy z pojemnikiem	9 761	10 148	10 435	10 770	11 345	12 381	15 519	17 936	1,3	48	1	
SEGM.1OT L/P	BOK A 105/102/92 BOK B 96/102/92		Element modułowy/otomana z pojemnikiem	13 025	13 822	14 420	15 102	16 153	17 083	19 488	21 003	1,65	85	1	

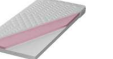
SYMBOL	ROZMĚRY (š / h / v)	POPIS	CENY										OBJEM (m3)	VÁHA (kg)	MNOŽSTVÍ (ks)									
			A1	A2	B1	B2	B3	B4	S1	S2														
VNITŘNÍ PRVKY	SEGM.2BF BB	145/102/92		Element modułowy wewnętrzny										10 604	11 173	11 591	12 083	12 816	13 474	20 146	21 562	1,70	43	1
	SEGM.2,5S BB	145/102/92		Element modułowy wewnętrzny z funkcją spania, pow.spania 120x196, możliwość wyboru materaca: VP, HR lub VISCO										18 238	18 883	19 350	19 907	20 741	21 474	28 337	29 752	1,80	119	1
	SEGM.3BF BB	165/102/92		Element modułowy wewnętrzny										11 299	11 867	12 285	12 778	13 512	14 168	22 687	24 318	2,00	53	1
	SEGM.3S BB	165/102/92		Element modułowy wewnętrzny z funkcją spania, pow.spania 140x196, możliwość wyboru materaca: VP, HR lub VISCO										19 325	20 045	20 564	21 184	22 105	22 928	30 928	32 559	1,90	130	1
	SEGM.3,5 BB	185/102/92		Element modułowy wewnętrzny										12 260	12 892	13 335	13 878	14 687	15 407	24 609	26 391	2,00	63	1
	SEGM.3,5S BB	185/102/92		Element modułowy wewnętrzny z funkcją spania, pow.spania 160x196, możliwość wyboru materaca: VP, HR lub VISCO										21 512	22 296	22 865	23 534	24 546	25 442	34 265	36 047	2,00	140	2
MATRACE	MAT.VP.120	120/196/14		materac wykonany z pianki poliuretanowej o grubości 14 cm, obsyty membranową tkaniną materacową , wykończony obustronnie lamówką										2 970					MATRACE BALENÁ S ROŠTEM					
	MAT.HR 120	120/196/14		materac wykonany z pianki wysokoelastycznej o grubości 14 cm, obsyty membranową tkaniną materacową , wykończony obustronnie lamówką										4 830					MATRACE BALENÁ S ROŠTEM					
	MAT.VISCO 120	120/196/14		materac dwurdzeniowy, połączenie pianki wysokoelastycznej z pianką termoelastyczną (memory foam), grubość materaca 14 cm, całość obszyta membranowa tkanina materacową , wykończoną obustronnie lamówką										6 870					MATRACE BALENÁ S ROŠTEM					
	MAT.VP.140	140/196/14		materac wykonany z pianki poliuretanowej o grubości 14 cm, obsyty membranową tkaniną materacową , wykończony obustronnie lamówką										3 290					MATRACE BALENÁ S ROŠTEM					
	MAT.HR 140	140/196/14		materac wykonany z pianki wysokoelastycznej o grubości 14 cm, obsyty membranową tkaniną materacową , wykończony obustronnie lamówką										5 820					MATRACE BALENÁ S ROŠTEM					
	MAT.VISCO 140	140/196/14		materac dwurdzeniowy, połączenie pianki wysokoelastycznej z pianką termoelastyczną (memory foam), grubość materaca 14 cm, całość obszyta membranowa tkanina materacową , wykończoną obustronnie lamówką										7 230					MATRACE BALENÁ S ROŠTEM					

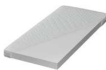
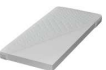
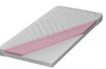
SYMBOL	ROZMĚRY (š / h / v)	POPIS	CENY								OBJM (m3)	VÁHA (kg)	MNOŽST VÍ (ks)	
			A1	A2	B1	B2	B3	B4	S1	S2				
MATRACE	MAT.VP.160	160/196/14		3 690								MATRACE BALENÁ S ROŠTEM		
	MAT.HR 160	160/196/14		5 990								MATRACE BALENÁ S ROŠTEM		
	MAT.VISCO 160	160/196/14		7 690								MATRACE BALENÁ S ROŠTEM		

ROZMĚRY (cm)	
hloubka nábytku	88
výška nábytku	89
výška sezení	46
hloubka sezení	55
šířka boku / výška boku	24/63

ČALOUNĚNÍ	
koordináty	ne
doplňkové prošití v kůži	ano
omezení tkanin a kůží	tkaniny se vzory
kontrastní prošití	ne

NOHY	
	
NOHA DŘEVĚNÁ N	NOHA KOVOVÁ CR

ZPŮSOB ROZKLÁDÁNÍ FUNKCE SPANÍ						
						
ROZKLÁDÁNÍ TYPU 01 (DELFIN)				ROZKLÁDÁNÍ TYPU 07 (rošt)		







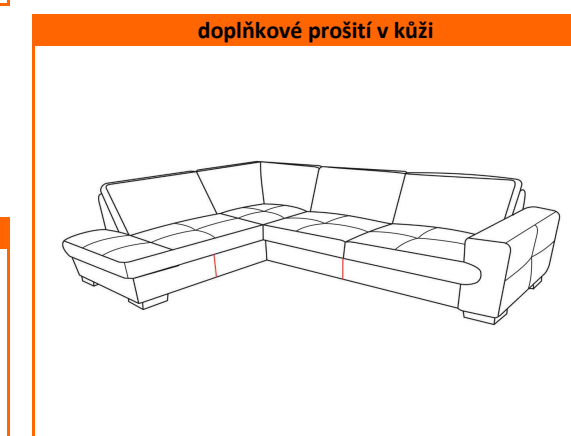



ostatní	
1.	V případě tkanin: CARABU HT se mohou vyskytnout potíže při rozkládání funkce spaní
2.	U kůží je použito doplňkové prošití
3.	Nohy dřevěné dostupné v 10 barvách
4.	Uvedené ceny jsou cenami částečnými. Pro získání celkové prodejní ceny je potřeba sečíst jednotlivé prvky sestavy a boky, a to zapsané zleva doprava, jak jdou po sobě
5.	S ohledem na měkké prvky a způsob ocalounění se mohou vyskytnout malé rozdíly v rozměrech nábytku
6.	Správný postup zápisu vybraných prvků na objednávce je jejich postupné uvedení zleva doprava







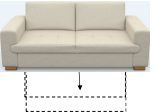

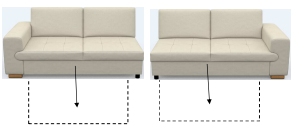



FUNKCE	
funkce spaní	delfin / matrace na pružinových lištách: SEGM.2W BB, SEGM.2,5W, SEGM.2,5W BB rošt - SOF.2,5S
úložný prostor	ano - SEGM.1P, SEGM.2P













SLOŽENÍ	
opěrák	pěna polyuretanová/potah s výplní silikonu
sedák	pěna vysoce elastická/pěna polyuretanová/lištová pružina







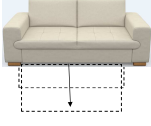



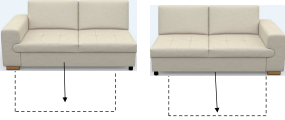









TABOO

	ROZMĚRY v cm (š / h / v)		POPIS	CENY								OBJEM (m3)	VÁHA (kg)	MNOŽSTVÍ (ks)
				A1	A2	B1	B2	B3	B4	S1	S2			
NOHA KOVOVÁ CR		100/88/89	křeslo	9 360	9 870	10 230	10 669	11 310	11 896	18 140	19 209	0,85	40	1
		78/88/89	moduľ	7 390	7 780	7 990	8 365	8 847	9 358	13 578	14 545	0,65	34	1
		56/88/89	moduľ	4 980	5 490	5 690	5 901	6 236	6 579	8 990	9 795	0,50	30	1
		176/88/89	pohovka-2osobova	12 990	13 790	14 290	14 944	15 985	16 914	25 714	26 812	1,50	51	1
		154/88/89	moduľ	11 270	11 860	12 290	12 806	13 578	14 256	20 947	22 221	1,30	50	1
		132/88/89	moduľ	9 590	10 230	10 590	10 990	11 728	12 332	16 756	18 225	1,10	40	1
		132/88/89	moduľ z funkcj spania, moze byt stosowany wyłcznie do budowy narożnikw, pow. spania wynosi min. 120x187	12 481	13 048	13 457	13 940	14 666	15 315	19 581	21 003	1,00	56	1
		196/88/89	pohovka 2- osobova	14 790	15 560	15 990	16 746	17 722	18 578	27 461	29 275	1,60	59	1
		196/88/89	pohovka 2-osobova z funkce spani pow. Spania: 131x190	21 390	22 180	22 690	23 364	24 330	25 195	33 530	36 272	1,60	108	1
		174/88/89	moduľ	12 592	13 233	13 699	14 246	15 073	15 808	23 020	24 794	1,45	53	1
	174/88/89	moduľ z funkcj spania, moze byt stosowany wyłcznie do budowy narożnikw, pow. spania wynosi min. 120x200	15 325	15 975	16 431	16 980	17 815	18 550	25 668	27 703	1,45	72	1	

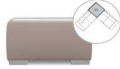
	ROZMĚRY v cm (š / h / v)		POPIS	CENY								OBJEM (m3)	VÁHA (kg)	MNOŽSTVÍ (ks)	
				A1	A2	B1	B2	B3	B4	S1	S2				
NOHA KOVOVÁ CR	SEGM.2,5BF BB-0025		152/88/89	moduľ	10 901	11 431	11 803	12 259	12 937	13 532	18 828	20 725	1,25	47	1
	SEGM.2,5W BB-0025W		152/88/89	moduľ z funkcj spania, moze byť stosowany wyłcznie do budowy naroźnikw, pow. spania wynosi min. 120x187	13 447	14 135	14 526	14 981	15 660	16 254	21 180	23 410	1,25	59	1
	SOF.3BF-2030 CR		216/88/89	pohovka 3-osobowa	15 790	16 570	16 990	17 853	18 903	19 841	29 005	31 273	1,80	69	1
	SEGM.3BF L-1130 / P-1230 CR		194/88/89	moduľ	13 205	13 903	14 395	14 991	15 892	16 681	24 488	26 291	1,60	60	1
	SEGM.3BF BB-0030		172/88/89	moduľ	11 431	12 053	12 473	12 965	13 708	14 367	20 353	22 147	1,40	55	1
	SEGM.1P L-5110/ P-5210 CR		175/98/89	moduľ z pojemnikiem	13 411	14 024	14 460	14 991	15 790	16 486	23 959	25 175	1,60	63	1
	SEGM.2P L-5120/ P-5220 CR		196/85/89	moduľ z pojemnikiem	15 315	16 013	16 506	17 101	17 983	18 773	25 650	27 453	1,60	67	1
	SEGM.1M L-3110/ P-3210 CR		112/88/89	moduľ	8 058	8 448	8 718	9 043	9 572	10 120	14 395	15 390	0,90	32	1
	SEGM.H-7010		85/85/89	moduľ	8 643	9 043	9 331	9 674	10 288	10 865	14 117	15 259	0,70	31	1
STS.-8385 CR		85/85/42	stolik z blatem ze szkła hartowanego	5 190	5 470	5 670	5 890	6 311	6 672	8 726	9 805	0,30	36	1	
STS.H-8385H CR		85/85/42	moduľ łczcy prostopadle dwa elementy, obsahuje blat ze szkła hartowanego												
STS.I-8385I CR		85/85/42	moduľ łczcy rwnolegle dwa elementy, obsahuje blat ze szkła hartowanego												

	ROZMĚRY v cm (š / h / v)		POPIS	CENY								OBJEM (m3)	VÁHA (kg)	MNOŽSTVÍ (ks)
				A1	A2	B1	B2	B3	B4	S1	S2			
		90/90/46	pufa z pojemníkem	5 370	5 660	5 870	6 133	6 598	7 017	9 991	10 148	0,40	36	1
		60/60/46	pufa z pojemníkem	3 890	4 180	4 360	4 610	4 945	5 260	5 938	6 319	0,20	22	1
NOHA DŘEVĚNÁ N		100/88/89	křeslo	8 680	9 180	9 540	9 973	10 623	11 199	17 369	18 475	0,85	40	1
		78/88/89	moduľ	7 063	7 435	7 695	8 012	8 486	8 978	13 187	14 173	0,65	34	1
		56/88/89	moduľ	5 232	5 492	5 678	5 901	6 236	6 579	9 061	9 795	0,50	30	1
		176/88/89	pohovka 2-osobowa	12 390	12 990	13 580	14 182	15 213	16 143	24 953	26 059	1,50	51	1
		154/88/89	moduľ	10 919	11 514	11 942	12 453	13 225	13 903	20 557	21 840	1,30	50	1
		132/88/89	moduľ	9 600	10 231	10 604	11 059	11 728	12 332	16 756	18 225	1,10	40	1
		132/88/89	moduľ z funkcją spania, może być stosowany wyłącznie do budowy narożników, pow. spania wynosi min. 120x200	12 481	13 048	13 457	13 940	14 666	15 315	19 581	21 003	1,10	56	1
		196/88/89	pohovka 2-osobowa	13 990	14 860	15 390	15 990	16 990	17 872	26 682	28 541	1,60	59	1
	196/88/90	pohovka 2-osobowa z funkcją spania pow. spania: 131x190	19 990	20 890	21 470	22 119	22 990	23 949	32 759	34 934	1,60	108	1	
	174/88/89	moduľ	12 249	12 899	13 354	13 913	14 740	15 473	22 629	24 441	1,45	53	1	

	ROZMĚRY v cm (š / h / v)	POPIS	CENY								OBJEM (m3)	VÁHA (kg)	MNOŽSTVÍ (ks)
			A1	A2	B1	B2	B3	B4	S1	S2			
SEGM.2,5W L-1125W/ P-1225W N		174/88/89 modul z funkcí spania, může být stosovaný výhradně do budovy narožníků, pow. spania wynosi min. 120x200	14 637	15 427	15 985	16 635	17 462	18 197	25 278	27 342	1,45	72	1
SEGM.2,5BF BB-0025		152/88/89 modul	10 901	11 431	11 803	12 259	12 937	13 532	18 828	20 725	1,25	47	1
SEGM.2,5W BB-0025W		152/88/89 modul z funkcí spania, může být stosovaný výhradně do budovy narožníků, pow. spania wynosi min. 120x200	13 447	14 135	14 526	14 981	15 660	16 254	21 180	23 410	1,25	59	1
SOF.3BF-2030 N		216/88/89 pohovka 3-osobowa	14 990	15 860	16 450	17 147	18 197	19 135	28 234	30 538	1,80	69	1
SEGM.3BF L-1130/ P-1230 N		194/88/89 modul	12 852	13 550	14 042	14 637	15 539	16 328	24 098	25 910	1,60	60	1
SEGM.3BF BB-0030		172/88/89 modul	11 431	12 053	12 473	12 965	13 708	14 367	20 353	22 147	1,40	55	1
SEGM.1P L-5110/ P-5210 N		175/98/89 modul z pojemníkem	12 713	13 336	13 772	14 303	15 093	15 800	23 178	24 441	1,60	63	1
SEGM.2P L-5120/ P-5220 N		196/85/89 modul z pojemníkem	14 470	15 315	15 818	16 403	17 295	18 086	24 889	26 729	1,60	67	1
SEGM.1M L-3110/ P-3210 N		112/88/89 modul	7 695	8 076	8 355	8 680	9 192	9 739	14 014	15 019	0,90	32	1
SEGM.H-7010 N		85/85/89 modul	7 945	8 355	8 643	8 986	9 517	10 092	13 346	14 535	0,70	31	1

	ROZMĚRY v cm (š / h / v)	POPIS	CENY								OBJEM (m3)	VÁHA (kg)	MNOŽSTVÍ (ks)
			A1	A2	B1	B2	B3	B4	S1	S2			
SEGM.BOX.TAP-8485		34/88/60 modul vystupující výhradně jako łącznik dvou elementů, obsahuje unosený blat a pólku wnąkowá wykonaná z plyty laminowanej v kolorze antracyt	4 953	5 149	5 288	5 446	5 799	6 125	9 210	9 572	0,20	30	1
STS.-8385 N		85/85/42 stolik z blatem ze szkła hartowanego	4 490	4 770	4 970	5 213	5 567	5 901	7 955	9 061	0,30	36	1
STS.H-8385H N		85/85/42 modul łączący prostopadle dwa elementy, obsahuje blat ze szkła hartowanego											
STS.I-8385I N		85/85/42 modul łączący równolegle dwa elementy, obsahuje blat ze szkła hartowanego											
PUF.P 90x90-8190 N		90/90/46 pufa z pojemnikiem	4 660	4 960	5 160	5 417	5 827	6 236	9 210	9 414	0,40	36	1
PUF.P 60x60-8160 N		60/60/46 pufa z pojemnikiem	3 130	3 390	3 590	3 829	4 182	4 479	5 157	5 577	0,20	22	1
ZAG.M-9010		50/15/19 zágówek rekomendowany do wszystkich elementůw	1 210	1 290	1 360	1 441	1 562	1 664	1 757	1 923	0,05	2	1
ZAG.D-9020		70/15/19 zágówek rekomendowany do wybranych elementůw: 2,5; 3 a wszystkich otoman	1 280	1 390	1 470	1 570	1 719	1 840	1 998	2 183	0,05	2,5	1
MAT.		materacyk tapicerowany wláściwą tkaniną mebla, modułów z funkcją spania	892	1 152	1 358	1 580	1 933	2 546			netýká se		

ROZMĚRY (cm)	
hloubka nábytku	95
výška nábytku	102
výška sezení	46
hloubka sezení	55
šířka boku / výška boku	8/60

ČALOUNĚNÍ	
koordináty	ano
doplňkové prošití v kůži	netýká se
omezení tkanin a kůží	GENUA, RAJAN, VIENNA, KŮŽE
kontrastní prošití	ne



FUNKCE	
funkce spaní	ne
úložný prostor	ne
nastavitelné prvky	ne
ostatní	ne





SLOŽENÍ	
sedák	pěna vysoce elastická, lištová pružina
opěrák	pěna vysoce elastická, čalounický pás





ostatní

- Nábytek s koordináty
- S ohledem na měkké prvky a způsob očalounění se mohou vyskytnout malé rozdíly v rozměrech nábytku

WING



SYMBOL	ROZMĚRY (š / h / v)		POPIS	CENY						OBJEM (m3)	VÁHA (kg)	MNOŽSTVÍ
				A1	A2	B1	B2	B3	B4			
SOF.BF	136/95/102		pohovka	13 790	14 490	14 990	15 590	16 490	17 290			
FOT.BF	71/95/102		křeslo	8 590	8 990	9 380	9 795	10 390	10 929	0,7	30	1
PUF.46X46	46/46/45		Puf kwadratowy	2 790	2 950	2 990	3 151	3 309	3 466	0,1	8	1
PUF.FI56	fi56/45		Puf okrągły	2 890	2 990	3 090	3 188	3 345	3 484	0,15	8,5	1

SYMBOL	ROZMĚRY v cm (š / v)		POPIS	CENA					
				A1	A2	B1	B2	B3	B4
					MIU, QUEEN (novinka)	SILVER (novinka)	LAGUNA; SAND (novinka)	SPRING; KASTEL (novinka)	
POD.01		40x40	1. POLŠTÁŘEK DEKORAČNÍ 2. DOSTUPNÝ VE TKANINÁCH Z CELÉ KOLEKCE	370	460	550	650	740	830
POD.03		50x50	1. POLŠTÁŘEK DEKORAČNÍ ZAKONČEN OZDOBNOU SÍTKOU 2. DOSTUPNÝ VE TKANINÁCH Z CELÉ KOLEKCE	460	550	650	740	830	930

RITMO

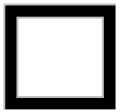

MATERIÁL ZÁKLADEN	MATERIÁL DESEK
<p>Rámy stolků dostupné ve dvou provedeních:</p> <ol style="list-style-type: none"> 1. Kovové, malované práškem na černo (CZ) 2. Kovové s povrchem chromovým (CR) 	<p>Desky stolků dostupné ve dvou provedeních:</p> <ol style="list-style-type: none"> 1. Vyrobené z lamina o tloušťce 16 mm, zakončené hranou ABS 2. Vyrobené z umělého kamene *(1) - o tloušťce 5 mm

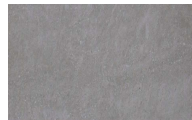









BAREVNOST								
PROFIL KOVOVÝ			DESKA DÝHOVANÁ			DESKA Z UMĚLÉHO KAMENE		
	černý, práškový CZ	chromový CR	dub přírodní barvený - bělený		dub přírodní barvený - ořech	bílý - bianco statuario BL	šedý - savoia grigia SZ	tmavý grafit- savoia antracit CG
								







OSTATNÍ	
<p>1.* UMĚLÝ KÁMEN - jde o křemennou desku s velkou pevností, vytvořenou z přírodních materiálů, jakou jsou: břidličné jíly, granitové horniny a keramické pigmenty. Materiál je 100 % ekologický, neobsahuje žádné doplňkové pryskiřice ani jiné plastové prvky</p> <p>2. Při objednávání je potřeba uvést správně typ základny a typ a barvu desky.</p>	



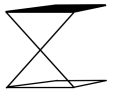





PLAY

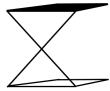
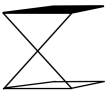

MATERIÁL ZÁKLADEN	MATERIÁL DESEK
Dřevěné nohy, dostupné ve dvou barvách: N4, N10	Horní desky stolků jsou vyrobeny z desky MDF, potažené matným lakem, dostupné v 8 barvách

BAREVNOST								
BAREVNOST DESEK								
								
7043 szary drogowy	7001 szary mchow	6025 zielony paprocio	9003 biały sygnalizacyjny	4002 niebiesko liliowy	3014 różowy antyczny	1019 beżowo szary	1005 zółty modowy	
BAREVNOST NOHOU								
								
N2	N4	N10						

SYMBOL		ROZMĚRY (š / h / v)	POPIS		CENY	OBJEM (m3)	VÁHA (kg)	MNOŽST VÍ
DESKY S UMĚLÝM KAMENEM	POM.30.CR.S	50/30/67		POMOCNIK Z CHROMOVANĄ PODSTAWĄ a BLATEM WYKONANYM ZE SPIEKU KWARCOWEGO W barvách DO WYBORU: BL, SZ, CG	5 990	0,1	8	1
	POM.30.ML.S	50/30/67		POMOCNIK Z KOVOVĄ PODSTAWĄ MALOVANĄ PROSZKOWO W barvách DO WYBORU: CZ a BLATEM WYKONANYM ZE SPIEKU KWARCOWEGO W barvách DO WYBORU: BL, KR, CG	4 580	0,1	8	1
	STK.65.CR.S	65/65/37		STOLIK Z CHROMOVANĄ PODSTAWĄ a BLATEM WYKONANYM ZE SPIEKU KWARCOWEGO W barvách DO WYBORU: BL, SZ, CG	13 990	0,2	10,5	1
	STK.65.ML.S	65/65/37		STOLIK Z KOVOVĄ PODSTAWĄ MALOVANĄ PROSZKOWO W barvách DO WYBORU: CZ a BLATEM WYKONANYM ZE SPIEKU KWARCOWEGO W barvách DO WYBORU: BL, SZ, CG	6 760	0,2	10,5	1
	STK.75.CR.S	75/75/44		STOLIK Z CHROMOVANĄ PODSTAWĄ a BLATEM WYKONANYM ZE SPIEKU KWARCOWEGO W barvách DO WYBORU: BL, SZ, CG	14 990	0,25	13	1
	STK.75.ML.S	75/75/44		STOLIK Z KOVOVĄ PODSTAWĄ MALOVANĄ PROSZKOWO W barvách DO WYBORU: CZ a BLATEM WYKONANYM ZE SPIEKU KWARCOWEGO W barvách DO WYBORU: BL, SZ, CG	8 260	0,25	13	1
	STK.100.CR.S	100/60/41		STOLIK Z CHROMOVANĄ PODSTAWĄ a BLATEM WYKONANYM ZE SPIEKU KWARCOWEGO W barvách DO WYBORU: BL, SZ, CG	17 470	0,28	16	1
	STK.100.ML.S	100/60/41		STOLIK Z KOVOVĄ PODSTAWĄ MALOVANĄ PROSZKOWO W barvách DO WYBORU: CZ a BLATEM WYKONANYM ZE SPIEKU KWARCOWEGO W barvách DO WYBORU: BL, SZ, CG	9 150	0,28	16	1

SYMBOL		ROZMĚRY (š / h / v)	POPIS		CENY	OBJEM (m3)	VÁHA (kg)	MNOŽSTVÍ
DESKY Z LAMINA	POM.30.CR.L	50/30/69		POMOCNIK Z CHROMOVANĄ PODSTAWĄ a BLATEM WYKONANYM Z DESKY DÝHOVANÉ v barvách DN a DO	4 690	0,1	8	1
	POM.30.ML.L	50/30/69		POMOCNIK Z KOVOVĄ PODSTAWĄ MALOVANĄ PROSZKOWO W barvách DO WYBORU: CZ a BLATEM WYKONANYM Z DESKY DÝHOVANÉ v barvách DN a DO	3 280	0,1	8	1
	STK.65.CR.L	65/65/39		STOLIK Z CHROMOVANĄ PODSTAWĄ a BLATEM WYKONANYM Z DESKY DÝHOVANÉ v barvách DN a DO	10 860	0,2	10,5	1
	STK.65.ML.L	65/65/39		STOLIK Z KOVOVĄ PODSTAWĄ MALOVANĄ PROSZKOWO W barvách DO WYBORU: CZ a BLATEM WYKONANYM Z DESKY DÝHOVANÉ v barvách DN a DO	3 440	0,2	10,5	1
	STK.75.CR.L	75/75/46		STOLIK Z CHROMOVANĄ PODSTAWĄ a BLATEM WYKONANYM Z DESKY DÝHOVANÉ v barvách DN a DO	11 730	0,25	13	1
	STK.75.ML.L	75/75/46		STOLIK Z KOVOVĄ PODSTAWĄ MALOVANĄ PROSZKOWO W barvách DO WYBORU: CZ a BLATEM WYKONANYM Z DESKY DÝHOVANÉ v barvách DN a DO	3 890	0,25	13	1
	STK.100.CR.L	100/60/43		STOLIK Z CHROMOVANĄ PODSTAWĄ a BLATEM WYKONANYM Z DESKY DÝHOVANÉ v barvách DN a DO	13 320	0,28	16	1
	STK.100.ML.L	100/60/43		STOLIK Z KOVOVĄ PODSTAWĄ MALOVANĄ PROSZKOWO W barvách DO WYBORU: CZ a BLATEM WYKONANYM Z DESKY DÝHOVANÉ v barvách DN a DO	4 590	0,28	16	1
SYMBOL		ROZMĚRY (š / h / v)	POPIS		CENY	OBJEM (m3)	VÁHA (kg)	MNOŽSTVÍ
PLAY	STO.50	fi50/50			2 390	0,1	5	1
	STO.45	fi45/45			2 290	0,1	4	1

TKANINY/KŮŽE									
NÁZEV	ROZMĚRY	A1	A2	B1	B2	B3	B4	S1	S2
TKANINA	1 bm	490	660	780	940	1 160	1 570		
KŮŽE	1 m2*							1 970	2 040
* - minimální objednávka je 1 plát kůže									